

75 cents

hpr

focus
on
communications
technology . . .

ham radio

magazine

APRIL 1970

the multipurpose OPERATIONAL POWER SUPPLY

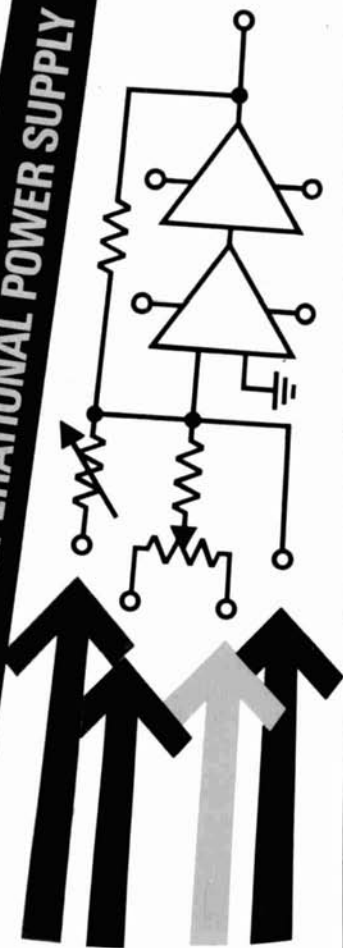

this month

- ssb speech processor 22
- 144-MHz kilowatt 26
- variable-bandpass
● audio filter 36
- capacitance meter 46
- dummy load/wattmeter 56

MEET THE NCX-1000 TRANSCEIVER... THE NEW DESKTOP POWER PACKAGE FROM NRCI



NRCI's compact new happening puts you on the air with *complete* SSB, CW, and AM coverage of the 80 through 10 meter bands. There's a lot in it for you, including built-in AC power supply and monitor speaker. Check these features, and you'll see this is the rig to stay with!

- 1000 Watts PEP on SSB, 1000 Watts CW, 500 Watts FSK, 500 Watts AM.
- All-solid-state except for driver and PA.
- Built-in RF speech clipper.
- Wide-range fast attack/slow decay AGC.
- Receive Vernier with separate on/off control.
- Suggested amateur net price, \$1095.



For complete (and impressive) specifications and details, write:

NATIONAL RADIO COMPANY, INC.

NRCI 37 Washington St., Melrose, Mass. 02176

SO YOU WANT CRYSTALS FASTER!



24
HOUR DELIVERY ON
ALL ORDERS OF TEN
CRYSTALS OR LESS

...well it will take someone
with manufacturing
"know how" to do it

But of more importance the crystal must be manufactured to Strict Specifications, have good activity and operate "on frequency" in the circuit for which it was ordered.

SENTRY can manufacture crystals for all two-way radio equipment: Commercial, Amateur, Aircraft, Military and Citizen Band. You need only to specify the model of set and channel frequency.

You don't believe it, when we say - "Buy the Best"?

You are satisfied with your present supplier?

You are satisfied with high prices?

You are satisfied with "second best"?

Until you try SENTRY you will never know!

Try Us! Make Us Prove It! "Buy the Best"

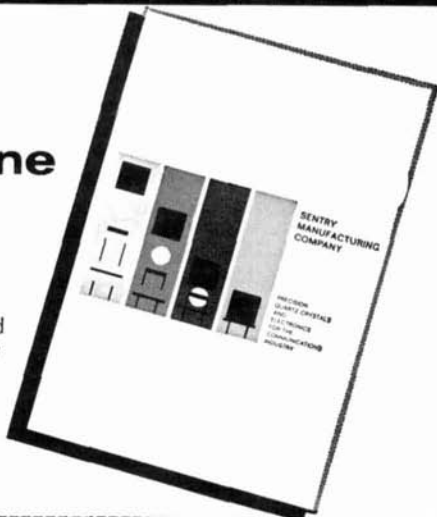

SEND FOR OUR CATALOG OF PRECISION
QUARTZ CRYSTALS AND ELECTRONICS
FOR THE COMMUNICATIONS INDUSTRY.
IT WILL COST YOU NOTHING!



SENTRY MANUFACTURING COMPANY

Crystal Park, Chickasha, Oklahoma 73018

PHONE: 405-224-6780

EAST MEETS WEST IN YEAR'S BIGGEST RECEIVER DEAL...

**\$234.50
OFF!**



SOLID STATE HQ-215 SSB/AM/CW/RTTY Ham/Commercial/Lab RECEIVER

Only the combined resources of the world's two largest amateur supply houses can bring you this sensational bargain — a whopping big \$234.50 reduction from the established net price of \$529.50!

*ALL BRAND NEW, LATEST PRODUCTION,
WITH FULL HAMMARLUND WARRANTY.*

Advanced state-of-the-art circuitry brings a new high in sensitivity, selectivity, and cool drift-free operation. Sharp 1KHz calibrations on 22 inch long dial — easily read to within 300 Hz. Large spinner knob gives smooth, velvet-touch tuning.

Revolutionary I-beam construction provides an unusually high degree of stability.

SENSITIVITY: Better than 0.5 microvolt for 10 db signal to noise ratio.

FREQUENCY RANGE: Can cover 3.4 to 30.2 MHz in dial controlled 200 KHz segments, each established by a crystal. Panel switch selects up to 24 plug-in crystals. Adaptable to 24 fixed frequency reception. Crystals are furnished for complete ham bands 80 thru 15 meters and 28.5-28.7 MHz.

STABILITY: Less than 200 Hz per hour, after 15 minutes.

SELECTIVITY: Collins SSB 2.1 KHz 2:1 shape factor mechanical filter supplied. Sock ets for two additional filters Panel switchable.

- 41 Solid State Devices.
- Selectable USB, LSB, CW, AM.
- Operates on 115/230 AC, 12 VDC.
- 7" x 16" x 14"D - 21 lbs.

Don't delay — they're going fast! Send \$295.00 today, or as little as 10% deposit. (Credit terms available — write.) TRADE-INS ACCEPTED

ORDER FROM

Henry Radio

11240 W. Olympic Blvd., Los Angeles, Calif. 90064
213/477-6701
931 N. Euclid, Anaheim, Calif. 92801 714/772-9200
Butler, Missouri 64730 816/679-3127

OR

Harrison

"HAM HEADQUARTERS, USA"

Rte. 110 at Smith • Farmingdale, N.Y. 11735
Phone (516) 293-7990
8 Barclay St. • New York City BARclay 7-7922
139-20 Hillside • Jamaica, N.Y. RE 9-4101

april 1970
volume 3, number 4

staff

James R. Fisk, W1DTY
editor

Nicholas D. Skeer, K1PSR
vhf editor
J. Jay O'Brien, W6GDO
fm editor

A. Norman Into, Jr., W1CCZ
Alfred Wilson, W6NIF
James A. Harvey, WA6IAK
associate editors

Jean Frey
art director
Wayne T. Pierce, K3SUK
cover

T. H. Tenney, Jr. W1NLB
publisher

offices

Greenville, New Hampshire 03048
Telephone: 603-878-1441

ham radio magazine is
published monthly by
Communications Technology, Inc.
Greenville, New Hampshire 03048

Subscription rates, world wide:
one year, \$6.00, three years, \$12.00.
Second class postage
paid at Greenville, N. H. 03048
and at additional mailing offices

Foreign subscription agents:
United Kingdom:
Radio Society of Great Britain,
35 Doughty Street, London WC1, England.

All European countries:
Eskil Persson, SM5CJD, Frotunagrand 1,
19400 Upplands Vasby, Sweden.

Copyright 1970 by
Communications Technology, Inc.
Title registered at U. S. Patent Office.
Printed by Wellesley Press, Inc.
Wellesley, Massachusetts 02181, U.S.A.

ham radio is available to the blind
and physically handicapped on magnetic tape
from Science for the Blind,
221 Rock Hill Road, Bala Cynwyd,
Pennsylvania 19440.

Microfilm copies of current
and back issues are available
from University Microfilms,
313 N. First Street, Ann Arbor,
Michigan 48103.

Postmaster: Please send form 3579 to
ham radio magazine, Greenville,
New Hampshire
03048.



contents

- 8 **operational power supply**
Richard C. Factor, WA2IKL
- 22 **ssb speech processor**
R. Lee Price, K6PHT
- 26 **high-power 144-MHz linear**
Robert I. Sutherland, W6UOV
Raymond F. Rinaudo, W6ZO
Merle B. Parten, K6DC
- 30 **electronic thermometer**
James W. Goding, VK3ZNV
- 32 **catalina wireless 1902**
E. H. Marriner, W6BLZ
- 36 **variable bandpass audio filter**
Gary B. Jordan
- 40 **432-MHz power amplifier**
James W. Brannin, K6JC
- 42 **improving 75A4 overload response**
Raymond F. Rinaudo, W6ZO
- 46 **direct-reading capacitance meter**
A. Mark King, ZL2AUE
- 51 **electronic digital clock**
Osburne C. Stafford, K4ALS
- 56 **low-power dummy load/wattmeter**
Neil A. Johnson, W2OLU
- 60 **how to use a sweep generator**
Larry Allen
- 68 **all-band 10-dB power attenuator**
Chester L. Smith, K1CCL
- 73 **vswr limit circuits**
John J. Schultz, W2EEY

- 4 **a second look** 84 **new products**
- 94 **advertisers index** 20 **next month**
- 85 **flea market** 60 **repair bench**
- 78 **ham notebook**

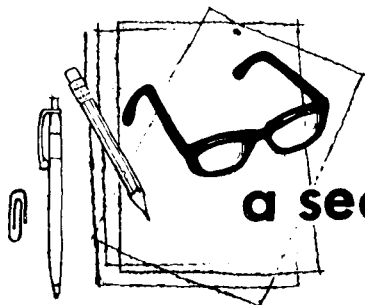

a second look

As you are probably aware, amateur radio is not in the middle of one of its more noticeable growth periods. In fact, licensing figures over the past year or so indicate that we're just about holding our own, and that's all. This may seem a bit unusual in these days of exploding population and growing technology, but when you look further and try to define the place where ham radio fits into our society it makes a little more sense.

No longer do you have to have an amateur radio license to taste the thrill of two-way radio communication. CB has opened this door to thousands, some of whom might otherwise have become hams. This unquestionably has had an adverse effect on the numerical growth of amateur radio, but perhaps it also has a bright side.

It takes a good deal of inertia to learn the requirements for a ticket and to organize one's self into a study program to prepare for the exam. After passing the test the new licensee must put together a station and actually get on the air. It doesn't just happen; he has to work for it. It has been estimated that as many as 50% of those passing the novice test never get on air!

Where does this lead us? We feel, in a very positive direction. It's always easy to achieve size by sacrificing quality; amateur radio is growing in stature and capability. For example, who would have dreamed a few years ago of the remarkably efficient and dependable local communications which have been established on 2-meter fm? The exciting accom-

plishments of the Oscar program and moonbounce have certainly helped make ham radio a hobby which can show much pride of achievement. Our growing mastery of RTTY, slow-scan tv and facsimile further attest to our desire to explore and develop new ideas. The transition to ssb has opened up technological and communications capabilities virtually undreamed of twenty-five years ago.

We must continually re-evaluate ourselves to make sure that we are taking maximum advantage of our privileges. We must also consider what future changes might do. We have all seen such ideas as the mighty incentive controversy and the liberalizing of novice license provisions. Currently new ideas such as putting technicians on 10 meters are being evaluated.

Some of these ideas will work out while others will be scrapped. However, we *must not* rely on the past to provide a blueprint for the future. It's important that we try to structure our activities to take advantage of any interesting new challenges which we find. Communications is in for a number of violent changes in the years ahead and amateur radio should do its best to be in the middle of the action -- satellite repeaters and data transmission techniques are just two possibilities that come to mind. It goes without saying that your shiny new ssb transceiver will be just as *obsolete in the years to come* as a two-tube regenerative receiver is today. *Ham radio* will do everything it can to guide you into this new age.

Skip Tenney, W1NLB
publisher

EIMAC's new family of outstanding power tetrodes offers 13 impressive features:-



4CX600B
4CX600F

4CW800B
4CW800F

4CX600J
8809

- (1) High linearity. 3d order products —40 dB or better.
- (2) Low input capacitance. Typically, 45 pF.
- (3) Over 600 watts measured output at 865 MHz.
- (4) Very high gain-bandwidth product. Over 125 MHz.
- (5) Low grid interception in linear amplifier service.
- (6) Low drive. Typically 40 volts for class AB-1 service. Easily driven at 150 MHz with 5 watt solid state device.
- (7) Plate dissipation up to 800 watts. Both air and liquid cooling available.
- (8) Coaxial base adapter available.
- (9) Shock-resistant design for rugged service.
- (10) 20 kW pulse output at 430 MHz.
- (11) Very low cathode lead inductance.
- (12) 5-pin base adapted for heat-sink cooling.
- (13) High grid and screen dissipation ratings.

The unique 4CX600 family is an exciting result of EIMAC's CAD (computer-aided-design) program for ceramic/metal tetrodes. Closely controlled parameters permit intermodulation distortion limits to be included as a defining tube characteristic, establishing new criteria of performance.

EIMAC's advanced segmented cathode and electron focussing combine with an unusually high figure of merit in this family, providing you with tubes useful in widely diversified services: linear amplification, high reliability aircraft-to-ground communication, wideband

distributed amplifier service in airborne ECM gear, and r-f pulse application.

Another example of EIMAC's ability to provide tomorrow's tube today! Here are the numbers to prove it:

TUBE TYPE	FIL VOLTS	RATED TO (MHz)	BASE	COOLING	MAX. RATINGS		TYPICAL POWER OUTPUT (150 MHz)	USEFUL FOR:
					Plate Volts	Plate Amperes		
4CX600B	6.0	890	5-PIN SPEC.	Air	3000	0.6	750W	WIDEBAND AMPLIFIER SERVICE
4CX600F	26.5							
4CW800B	6.0	890	5-PIN SPEC.	Liquid	3000	0.6	750W	WIDEBAND AMPLIFIER SERVICE
4CW800F	26.5							
4CX600J 8809	6.0	150	DCIAL SPEC.	Air	3000	0.6	750W	CLASS AB-1 LINEAR SERVICE

More? Our Application Engineering Department's ability to design tube into circuit means less engineering time for you. For all-around capability, talk to EIMAC. For circuit and application information on these new power tetrodes, write to EIMAC for our new, free application bulletin #14, *Using the 4CX600 Family Tetrodes*. Or contact your nearest Varian/Eimac Electron Tube and Device Group Office. They are located in:

Albuquerque, N. M.
Alexandria, Va.
Atlanta, Ga.
Cherry Hill, N. J.
Clearwater, Fla.

Dayton, Ohio
Los Altos, Calif.
Melville, L. I., N. Y.
Park Ridge, Ill.
Richardson, Texas

Santa Monica, Calif.
Scottsdale, Ariz.
Springfield, N. J.
Syracuse, N. Y.
Waltham, Mass.

International Sales Offices are located in:

Australia
Benelux
Brazil
Canada
France
Germany

Italy
Japan
Scandinavia
Switzerland
United Kingdom and
Ireland

division
varian

SHARP AS A LASER

THE SWAN MODEL SS-18 QUARTZ FILTER NETWORK

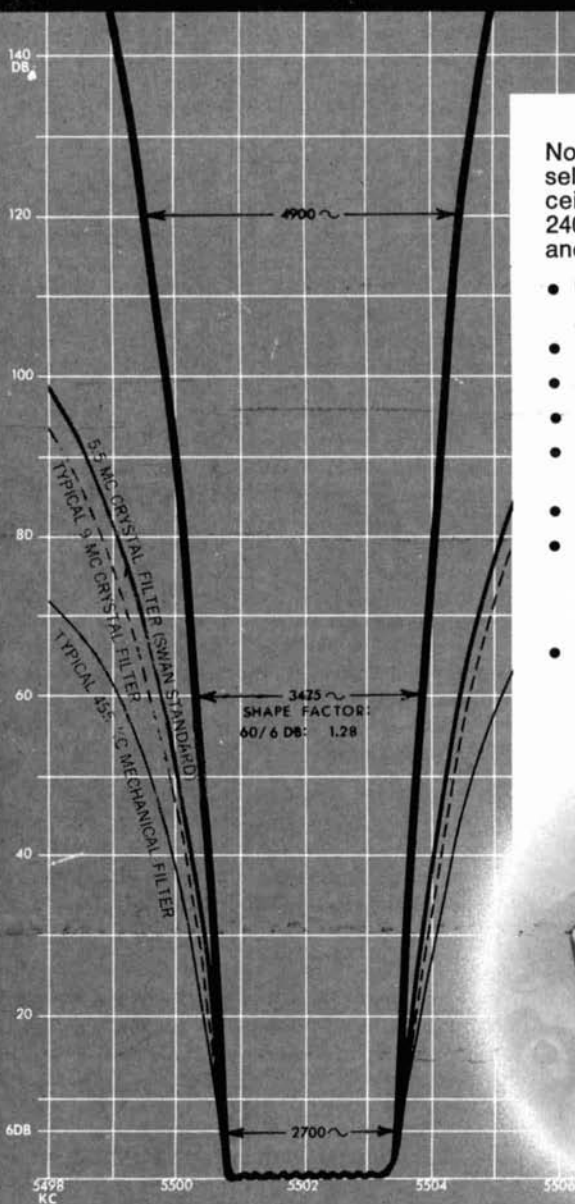

Now available to provide super selectivity for your Swan Transceiver. Easily installed in models 240, 260, 270, 350, 350C, 400, 500, and 500 C.

- Unprecedented rejection of adjacent channel QRM.
- 2.7 kc bandwidth at 6 db down.
- Shape factor 1.28.
- Ultimate rejection: 140 db.
- 16 poles. 16 precision crystals in a lattice filter network.
- Sideband suppression: 80 db.
- Carrier suppression: 45 db with the filter alone, plus approximately 40 db more from the balanced modulator.
- Mounting: Same as standard Swan filter, but taller.



Price: \$95
with instructions. Specify transceiver model.
See your Swan dealer today.



SWAN
ELECTRONICS

305 Airport Road
Oceanside, California 92054
A Subsidiary of Cubic Corporation

Selectivity has come a long way.

Today we take for granted shape factors and ultimate rejection figures that were considered either impossible or extremely expensive twenty years ago. Practically all single sideband equipment has a pretty good filter network in the I. F. system to establish the selectivity pattern. It may be a high frequency crystal lattice network, or the lower frequency mechanical type.

There are three factors about the I.F. filter that determine how well it will do its job. The one most commonly recognized is the width of the passband, usually measured at a point 6 db down from minimum attenuation.

This bandwidth is what determines the audio frequency range you can transmit and receive through the filter. The wider the passband, the wider the range of A.F. It becomes necessary, of course, to choose a happy compromise between a narrow bandwidth to help reduce QRM, and a wide bandwidth which will provide more natural sounding voice quality. You'll find that the Swan filter has a 2.7 kc bandwidth. This gets us into another subject which we'll discuss another time.

Shape factor is the next consideration in measuring a filter's quality. This is the ratio between bandwidth at 60 db and 6 db down, and is a measure of how steep the attenuation curve is outside the passband. This factor is often referred to as "skirt selectivity." The narrower the passband at 60 db down, the better the filter will attenuate strong adjacent channel signals. A good crystal lattice filter will have a shape factor of 1.7 to 2.0 depending on its center frequency. Best shape factors are achieved right around 5 mc, which is one of the important reasons for Swan's I.F. system being at 5.5 mc. On the other hand, the lower frequency mechanical filters don't have quite as good a shape factor as high frequency crystal filters, a fact which isn't very well known, and may come as a surprise to many.

Ultimate rejection is the third, but certainly not the least important measure of how good the filter is. All filters eventually "flare-out" at the base of their attenuation curve. This tells you how much the filter will attenuate signals which are 10 or more kilocycles outside the passband. If you have a base attenu-

ation level which is down 80 db, for example, a strong local signal may very well come through the receiver over quite a large portion of the band, and it won't be his fault! There's no point in telling him how broad he is if it's your filter that's falling down on the job. A good high frequency crystal filter having 6 or 8 poles will reach ultimate rejection levels of 100 db, or more. Here again, filters in the 5 mc region are better. So, all you happy Swan owners may as well know the facts and blow your horn a little. CF Networks has made that beautiful precision filter that's installed in your rig, and it's really a dandy.

The accompanying graph illustrates clearly what we've been talking about. But so far we've only been discussing the "standard" Swan filter, and comparing it with other typical 9 mc crystal filters and 455 kc mechanical filters. In case you hadn't noticed, there's a tall, skinny curve on the graph that's all alone. This is the new SS-16! Made exclusively for Swan by CF Networks, this 16 pole quartz filter network establishes a new standard of comparison. Shape factor of 1.28, ultimate rejection greater than 140 db! A giant QRM killer, the SS-16 wipes out strong adjacent channel interference with unprecedented attenuation. And in transmit mode, unwanted sideband and carrier suppression are both increased greatly. For a new experience in Super Selectivity, install the SS-16 in your Swan Transceiver. They are available for the current 5.5 mc, I.F., or the earlier 5.175 mc I.F. system. Installation and adjustment is quite simple, and our famous customer service department is, of course, available for assistance if required.

Sorry, the SS-16 is only available for Swan transceivers.

73



SWAN
ELECTRONICS

*For better ideas
in amateur radio.*

305 Airport Road
Oceanside, California 92054
A Subsidiary of Cubic Corporation

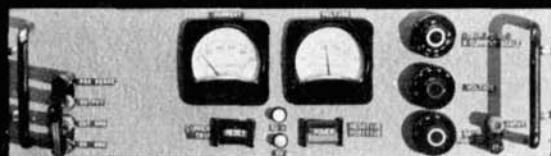

operational power supply

Regulated dc supply,
low-frequency amplifier,
current amplifier
with bipolar output—
these are just a few
uses for this
versatile instrument

The amateur literature is replete with power-supply articles. They range from the simplest transformer-rectifier-filter to sophisticated units with variable voltage control and super regulation. What do they all have in common? They're all designed to operate other equipment.

It seems a shame to use all this expensive regulation circuitry for such limited purposes. This article describes a power supply so versatile that it's called a "power supply" only because there's no generic term more applicable. The primary purpose of this unit is *not* to furnish power to another instrument. It is, instead, an instrument in its own right. In addition to being a highly regulated dc-voltage supply, it also functions as a low-frequency amplifier (flat response from dc to 10 kHz) with high-power output. Or it may be used as a current amplifier. The "supply," operating both in current and voltage modes, has bipolar output that can be varied continuously through zero. Thus, an arbitrarily low output may be obtained.

To protect any load, a variable current trip disconnects the output when the current exceeds any settable value between 10 mA and 3 amps. As an added convenience, the output-voltage meter has an automatic range switch. Also featured is a circuit that provides auto-

Richard Factor, WA2IKL, 30 West 60th Street, New York, New York 10023

matic polarity indication so the meters can be used on ac and dc.

Most of the critical circuits are contained in five readily available IC's. These include two type 709 operational amplifiers, one for regulation and one for metering; and three type 710 voltage comparators, one each in the range switching, polarity indicating, and overload protection circuits.

theory of operation

The circuit is basically an operational-

feedback around the transistor, nothing can compensate for these variations.

Fig. 1B can be a hundredfold better. It overcomes both of the above limitations. Very little current flows through the zener, and feedback through the zener and amplifier transistor compensates for the change in V_{be} . The principal objections are that the output isn't variable (except by changing the zener); also, if tight regulation is required, the gain of a single amplifier transistor isn't high enough to provide it.

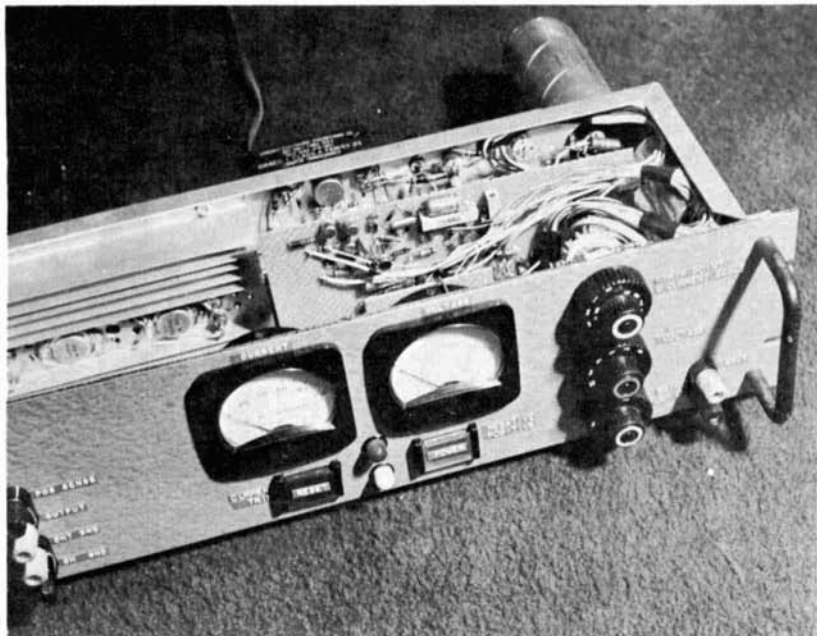

The operational power supply.

amplifier-controlled series regulator modified for bipolar operation. To understand how it works, let's review the theory of the series regulator and the operational amplifier. **Fig. 1** shows several series regulators, increasing in complexity and effectiveness.

Fig. 1A is a "regulator" with no feedback. It is merely an emitter follower with a fixed voltage on the base. Regulation is poor because the current through the zener varies substantially, and the V_{be} of the series pass transistor varies with the output current. Since there is no

Fig. 1C shows a differential amplifier. The circuit amplifies the difference between the reference voltage (supplied by the zener), and a sample of the output voltage (supplied by the potentiometer). This circuit allows the output voltage to be varied. Regulation percentage is again limited by the gain of the transistors.

op amp regulators

The best regulation is obtained with circuits that use operational amplifiers. The op amp is one of the most nearly universal analog circuits. An ideal opera-

tional amplifier has infinite voltage gain and zero output impedance. Obviously such characteristics are unattainable in

2. If the inverting input is more positive than the noninverting input, the output voltage assumes the most-

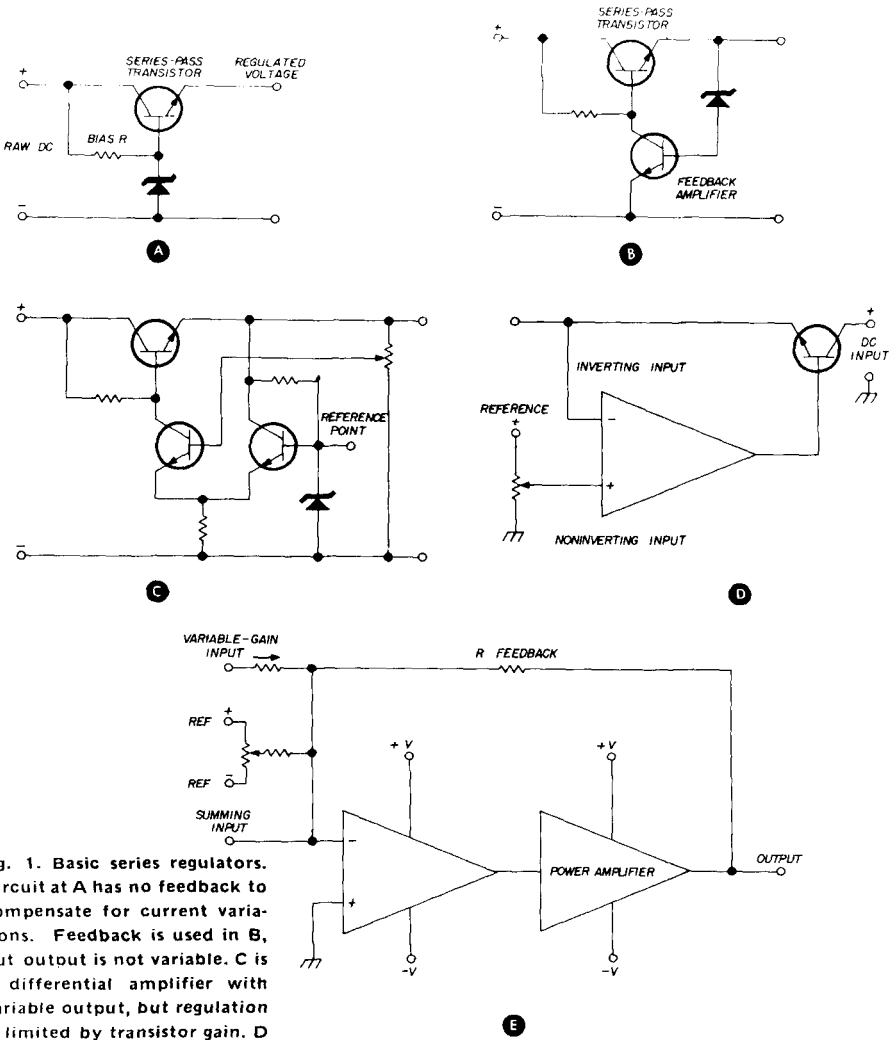

fig. 1. Basic series regulators. Circuit at A has no feedback to compensate for current variations. Feedback is used in B, but output is not variable. C is a differential amplifier with variable output, but regulation is limited by transistor gain. D is an op amp regulator. Circuit at E is the "Operational Power Supply".

practice, but op amps are almost always operated with a feedback network to control gain. This makes the assumption of ideality nearly correct.

When an op amp is operated without feedback, it is said to be operating "open loop." Its open-loop characteristics are as follows:

1. With no input voltage, output voltage is zero.

negative potential of which it is capable, just slightly more positive than the negative supply voltage. This is true regardless of how much voltage is applied to the input.

3. If the noninverting input is more positive than the inverting input, the output situation above is reversed.

4. If both inputs are shorted and a voltage is applied between them and

ground, no change in output voltage occurs. This is called "common mode rejection."

5. The input impedance is infinite.

To see how the op amp operates as a regulator, consider **fig. 1D**. The inverting input is connected to the output of the series pass transistor, and the non-inverting input is connected to a reference voltage. If any disturbance (such as a load) is introduced into the circuit that causes the inverting input to become negative with respect to the reference, the output voltage will immediately increase to compensate for it. Thus, the output voltage will be always equal to the reference. Since the input impedance is infinite, no current will be drawn from the reference.

input characteristics

Now we come to the most important derived property of the op amp. When enclosed in a negative-feedback loop, its differential input voltage will be zero. As in the above example, the output voltage will always vary so the two input terminals will be at the same potential. If the noninverting input is grounded, the inverting input will become a virtual ground, and any input voltages connected there (through resistors) will become pure currents. Several inputs can be connected simultaneously without any interaction.

Fig. 1E is a block diagram of the circuit used in the unit. Let's examine the properties of the inverting amplifier when a resistor ($R_{feedback}$) is included in the loop. Recalling that the input impedance is infinite, it's obvious that the voltage drop across the resistor is zero. Thus, there is just as much feedback without the resistor as with it. This is not precisely true, but true enough for a very good approximation.

Let $R_{feedback}$ be equal to 100 kilohms. So far we have a circuit whose output voltage is zero, since the non-inverting (reference) input is grounded. Connect a 10 kilohm resistor to the inverting input, along with the feedback resistor already there. Put ± 1 volt on the

other end of this resistor. The inverting input is at zero potential, so $100 \mu A$ must flow through the resistor. The op amp's input impedance is "infinite," so the current can't go there. To balance the current and the voltage, the output voltage must be -10 volts, so that $-100 \mu A$ must also flow through the feedback resistor to balance the circuit. By using these resistors, we have an inverting amplifier (also called a summing amplifier).

The application of this circuit to a power supply is obvious. Take a positive and negative reference, connect a variable



Rear view of the operational power supply showing the power transistors and adjusting controls.

resistor between them with its wiper connected to the input, and we have an extremely stable, bipolar, variable-voltage source. If a power amplifier is connected inside the feedback loop so that it actually becomes *part* of the op amp, we will have what I'll call an "Operational Power Supply," or *OPS*.

power supply or amplifier

I've avoided mentioning anything

other than dc voltages so far. Take a look at **figs. 1A through 1E**. None of the circuits depend on capacitors for filtering or regulation. This is important because it greatly enhances the time response of the

The IC's are available from several manufacturers. Any silicon diode with low leakage is okay for the signal diodes. Output transistors are HEP247 (npn) and HEP248 (pnp). Any silicon transistor with

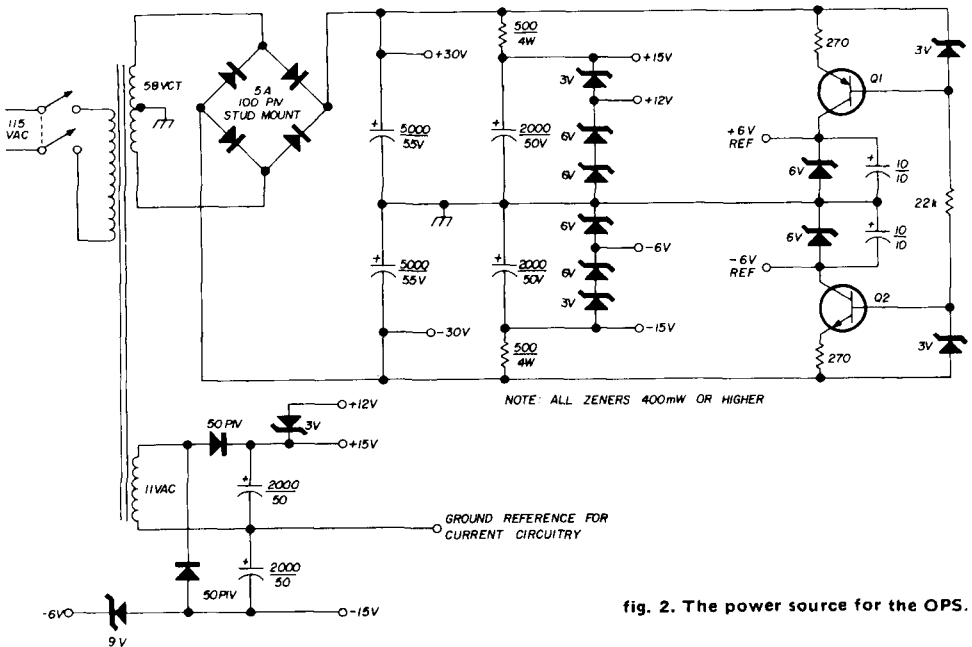

fig. 2. The power source for the OPS.

supply. The output will change from fully positive to fully negative in 100 μ s. Since it is so fast, the operational *power supply* could just as easily be used as an *amplifier*.

construction

The photos show the circuit layout and panel-component arrangement I used. However, these can be varied to suit your requirements and available parts. Most of the components were on hand. A wide range of values should be acceptable. Probably the biggest problem you'll have is finding a commercially available transformer that has a 58-volt ct secondary at 3 amps and an 11-volt secondary at 100 mA. By connecting filament transformer windings in series, it should be possible to obtain voltages sufficiently close to those shown.*

*A Variac in the primary might be helpful to make up whatever input voltages are necessary. Editor.

a 5-ampere or higher rating may be substituted. V_{ce} and V_{cb} should be at least 60 volts; 80 volts would be even better.

All zeners should have 1-watt dissipation or more. Their voltage values are shown in the schematics. All other transistors are 2N2905A (pnp) and 2N2219A (npn). Any device with similar ratings may be used.

Feel free to make substitutions. However, don't use electrolytic capacitors with values much lower than those specified. Critical components, such as meter shunts, are discussed in the parts of the article that describe the circuits. Be sure to use heat sinks for the two output transistors and rectifiers (photo).

power source

Fig. 2 shows the basic power source for the entire unit. Several voltages are required for the output stage, the IC's, and the reference supply. These are:

- +15 Referenced to ground for the regulator and voltage-metering portions.
- +12
- 6
- 15
- +15 Referenced to the output bus for the current metering and over-load-protection circuitry.
- +12
- 6
- 15
- +6 Stable, referenced to ground, to drive the operational amplifier input.
- 6

The first two groups are obtained by simple resistor-zener divider chains. The last group is obtained by using a positive and negative current source to drive the zener. Q1 and Q2 each have six-volt zeners in their collector circuits, with a fixed voltage drop across their emitter resistors. Since zeners are voltage stable with respect to current changes (except for a small slope after the "knee"), regulating the current keeps the zener operating over a very small portion of its curve, with a proportionally smaller change in voltage.

regulator circuit

Fig. 3 shows the actual circuit represented by fig. 1E. Theoretical operation has already been explained. Circuit details follow.

The two diodes connected back-to-back from the inverting input to ground protect the amplifier from high-voltage input transients. The capacitor and resistor between pins 1 and 8, and the capacitor between pins 5 and 6 give the proper high-frequency gain roll-off characteristics to the op amp.

The 100 kilohm resistor connected to the input is the main feedback resistor for the circuit. It is connected to the "sense" terminal on the front panel, which is normally shorted to the power-amplifier output.

Note that, in this circuit only, the inverting and noninverting inputs are reversed as to function, so don't be disturbed if the pin numbering doesn't correspond to that in the other diagrams. The reason for the reversal is that the power amplifier is itself an inverting amplifier, although one with relatively low voltage gain.

The circuit has one stage of voltage gain (Q3 and Q4), which drives compound emitter followers (npn Q5 and Q7; pnp Q6 and Q8). The diodes and 250-ohm potentiometer between the collectors of Q3 and Q4 are a biasing network that eliminates crossover distortion at output voltages near zero. The 250-ohm potentiometer should be adjusted for 60 mA quiescent current

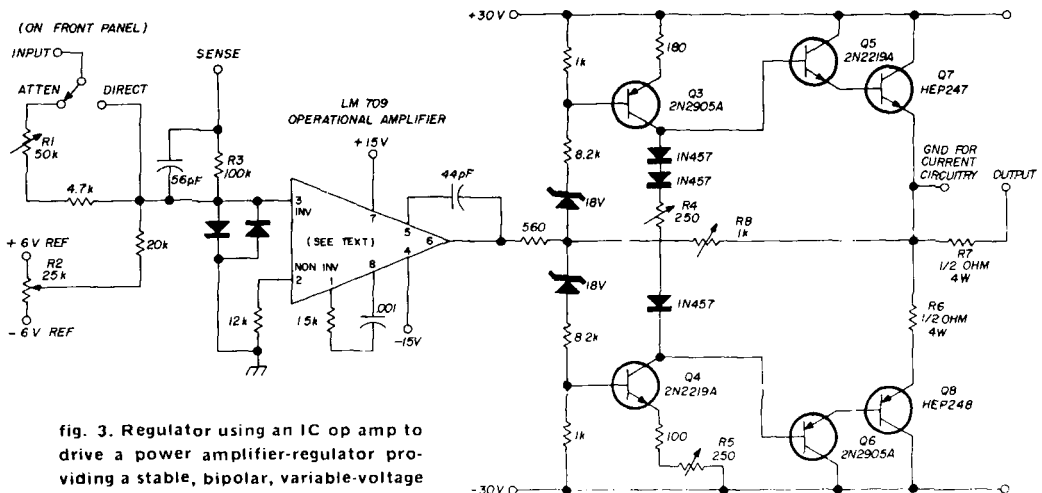

fig. 3. Regulator using an IC op amp to drive a power amplifier-regulator providing a stable, bipolar, variable-voltage source.

through R6, by measuring 30 mV across it. R5 balances out differences in the bias network of the voltage amplifier. It is adjusted by setting the supply output voltage to zero with R2, then measuring the voltage at pin 6 of the 709. The correct adjustment is reached when this

The circuit of **fig. 4** eliminates this difficulty. The ½-ohm resistor in series with the output is connected inside the feedback loop, so any voltage drop across it is compensated. A milliammeter of arbitrary value (less than 1 mA full-scale to avoid overloading the op amp) is

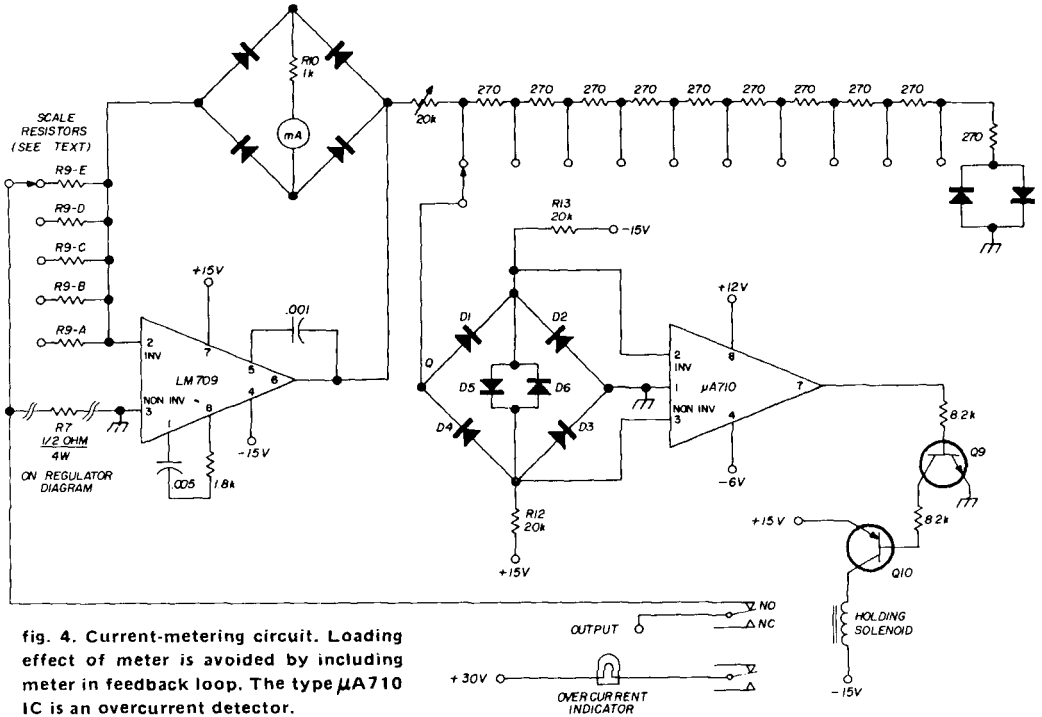

fig. 4. Current-metering circuit. Loading effect of meter is avoided by including meter in feedback loop. The type $\mu A710$ IC is an overcurrent detector.

voltage is between ± 1 volt. R8 should be adjusted so that at least a 16-volt peak-to-peak excursion (measured again at pin 6) produces a 60-volt peak-to-peak excursion at the output terminal. R7 is a shunt for current metering and is duplicated in **fig. 4**.

current metering

The usual method of measuring power supply current is to connect a meter in series with the supply. However, with highly regulated supplies, the output impedance is much lower than that of the meter, and the meter's insertion will seriously degrade performance.

connected in a bridge rectifier in the 709's feedback loop. Different series resistors are then switched to the inverting input.

Since the op amp input voltage is always zero, calculating the resistor values is very simple. Assuming the current you want to measure is 50 mA or greater and the meter is 1 mA (or less), just calculate the voltage across the ½-ohm resistor that corresponds to the full-scale current. Then find the resistance across which this voltage will give 1 mA. The characteristics of the meter do not enter into the computation. If you want to measure very low currents, it's necessary to cal-

culate the shunting effect of the metering resistor across the 1/2-ohm resistor, R7.

overcurrent detector

A type 710 voltage comparator is used as an overcurrent detector (fig. 4). It is similar to an op amp; however, instead of

output current and the range-switch setting. R11 is adjusted so that, with the divider switch in its least-sensitive position, the voltage at point Q overcomes the fixed bias on the comparator input at a point just after the current meter goes off scale. Changing taps on the divider

fig. 5. Voltage-metering. The μ A710 IC operates similarly to the overcurrent detector. A capacitor in the bridge circuit slows down range-switching action.

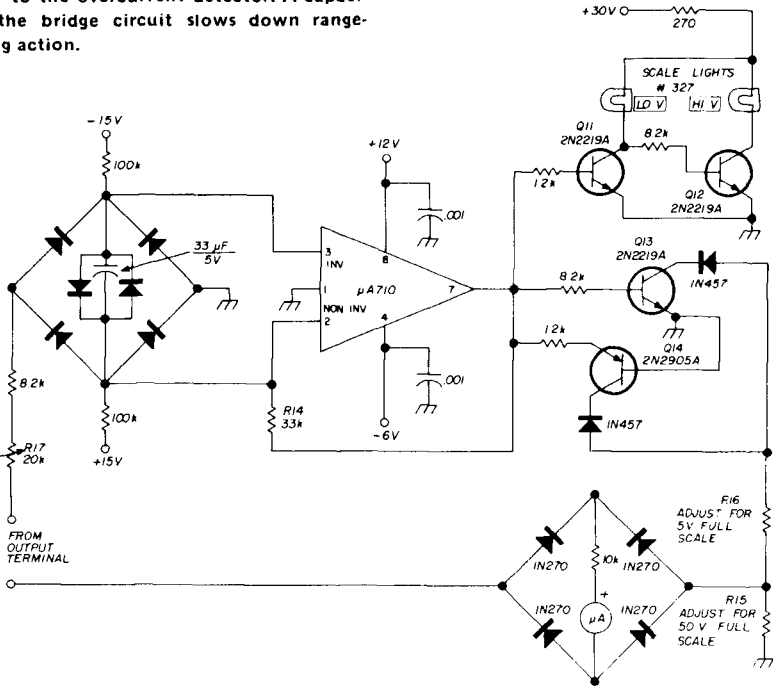

having a linearly varying output, its output voltage is either close to zero, if the inverting input is positive with respect to the noninverting input, or about 3 volts when the situation is reversed. By setting a reference voltage on one input, the comparator gives a digital output indicating whether the other input is higher or lower. The comparator is biased by R12 and R13 so that the output is at 3 volts. This biases Q9 into conduction as well as Q10, causing current to flow through the coil labeled "holding solenoid." The voltage at point Q is derived from the output of the op amp, which is in turn determined by the supply

enables cutoff to be set at several discrete points within the meter range.

The output interruptor is part of a switch that has a light and a solenoid. Current through the solenoid is sufficient to hold the switch in, but not to pull it in. Thus when the current is interrupted as the trip point is reached, the switch pops out and lights up, and must be manually reset. It would be just as simple to use a surplus 24-volt relay and reset button here, if you have no surplus computer switches handy. D1-D4 enable the comparator to work on ac, and D5-D6 protect the inputs from excessive voltage.

voltage metering

After all the foregoing complexity, it might disappoint you to learn that the voltmeter is merely a simple voltmeter. The range switching circuit (fig. 5) is a bit unusual, however. The comparator in this circuit works in a manner similar to that in the current trip. The only difference is that a $33\mu\text{F}$ capacitor is connected across the input to slow down the range switching action. The 33 kilohm resistor, R14, provides some hysteresis so that the up-range and down-range switch points aren't identical. Q11 and Q12 illuminate the appropriate scale lights so that you know what you are reading, and Q13 and Q14 shunt the low-range resistor to ground for both positive and negative excursions of the output.

range resistor adjustment

The range resistors are adjusted as follows. Disconnect the wire going to the shunting transistors, and set the supply output for 30 volts. Adjust R15 so the meter reads 30. Set the supply output for 5 volts. Adjust R17 so the high-range light just comes on. Reduce the output voltage to 4.5 volts. If the low-scale light hasn't come on yet, increase the value of R14 until it does. Now reconnect the wire to Q13 and Q14 and adjust R17 for a reading of 4.5 on the meter. Readings will be somewhat inaccurate below 2

volts, because it was necessary to use silicon diodes in series with the shunt to reduce leakage.

For the voltmeter, I used a 0-50

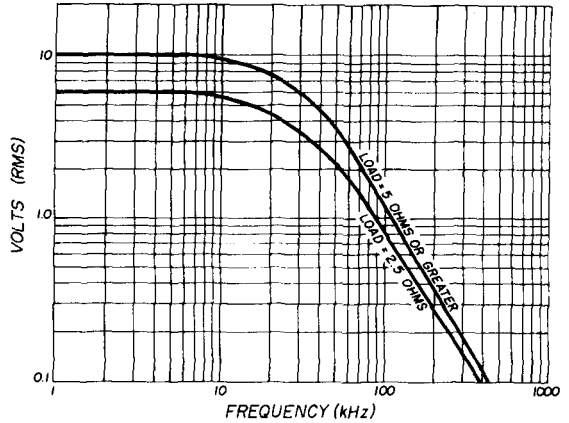
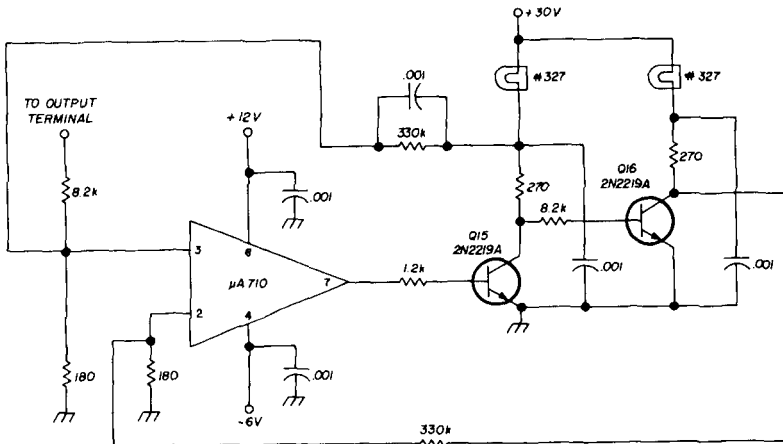

fig. 7. Frequency response of the OPS. Slope above 10 kHz is 20-dB/decade roll off to prevent oscillation.

microammeter. It makes little difference from a voltage-metering standpoint what you use, since the meter puts an insignificant load on the supply. However, as noted previously the supply can be used in a constant-current mode, in which any load in parallel with the desired one reduces the current regulation of the supply. If you don't have a very sensitive

fig. 6. Positive-negative output indicator. The IC comparator indicates +dc, -dc, or ac output.



meter, it's possible to use an operational amplifier to boost meter sensitivity. The bibliography at the end of the article gives several methods of doing this.

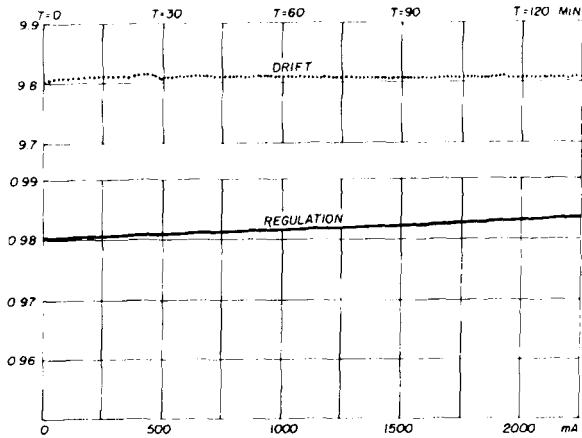

fig. 8. OPS regulation and drift performance.

positive-negative detector

There are several reasons for using a positive-negative output indicator (fig. 6) instead of a zero-center meter. One is that zero-center meters are difficult to come by. Another is that by using the entire scale to read voltage or current, resolution is improved 100 percent. Also, when measuring ac, a zero-center meter will indicate only the dc component of the signal. By arranging the metering so that both a positive and a negative output give

ground as a reference instead of a bias. Thus, if a voltage is below ground, one light is on; if above, the other is illuminated. The capacitors prevent the extremely fast operation of the comparator (under 50 nanoseconds) from radiating noise to the rest of the circuit.

performance

The drop-off in frequency response (fig. 7) might seem rather sharp, but only a portion of the graph is shown. The remaining response is flat down to dc. Above 10 kHz, a 20-dB-per-decade roll off is required so that the amplifier gain drops as the phase shift increases.

The regulation curve (fig. 8) may seem somewhat anomalous since it shows an increasing output voltage as the load increases. Actually, nothing particularly strange is happening here. The regulation at the terminals of the op amp is normal, but the distribution of the lead resistance inside the unit makes it appear otherwise. There are techniques for compensating for such effects, but there's little point in making the regulation better than the random variations of the output.

applications

So now you've built this fascinating gadget, with some blinking lights. You can't put it on a Christmas tree, nor is it heavy enough to make a decent boat anchor. So what to do with it? You can use it as a combination that has characteristics neither an amplifier nor a power supply alone possesses. The only limit is

fig. 9. The OPS as an electronic load. By varying input voltage, loads can be simulated without resistors.

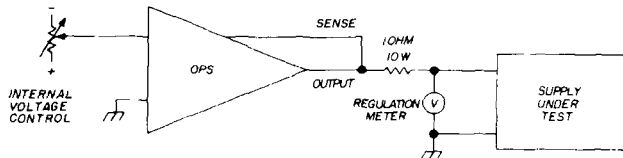

positive meter deflections, no switching is necessary for proper readings. The comparator circuit indicates if the output is +dc, -dc or ac (if both lights are lit).

The comparator works by using

your ingenuity. Below is a compilation of a few ideas I came up with.

electronic load

Due to the bipolar nature of the OPS,

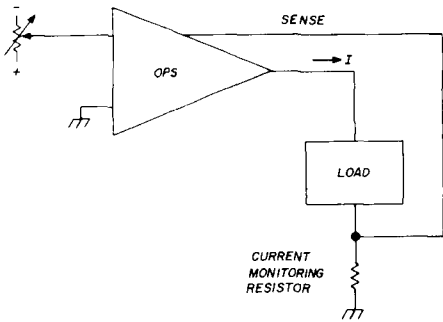

fig. 10. Current regulator application. Load is part of the feedback loop; a change in load resistance causes a corresponding output voltage change to maintain constant current.

it can absorb current as well as produce it. With a 1-ohm, 10-watt resistor, your power resistor problems are over. Assume you're testing a 10-volt power supply. Connect the resistor as shown in fig. 9. By varying the voltage on the ops from 10 to 7 volts, the load current changes from 0 to 3 amps. To test the supply with load resistors would require several, or at least one, with a 30-watt rating.

current regulator

The supply can be used as a current regulator. All that's required is a small

change in the output connection (fig. 10). To maintain a constant voltage across the current-monitoring resistor requires a constant current through it. The voltage, and hence the current, are determined by the dc-input current and the value of the current-monitoring resistor. The load is part of the feedback network, so a resistance change of the load causes a corresponding output voltage change to maintain constant current. If a capacitive

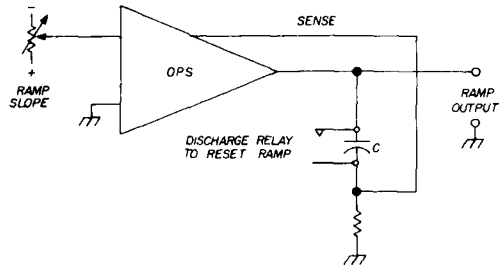
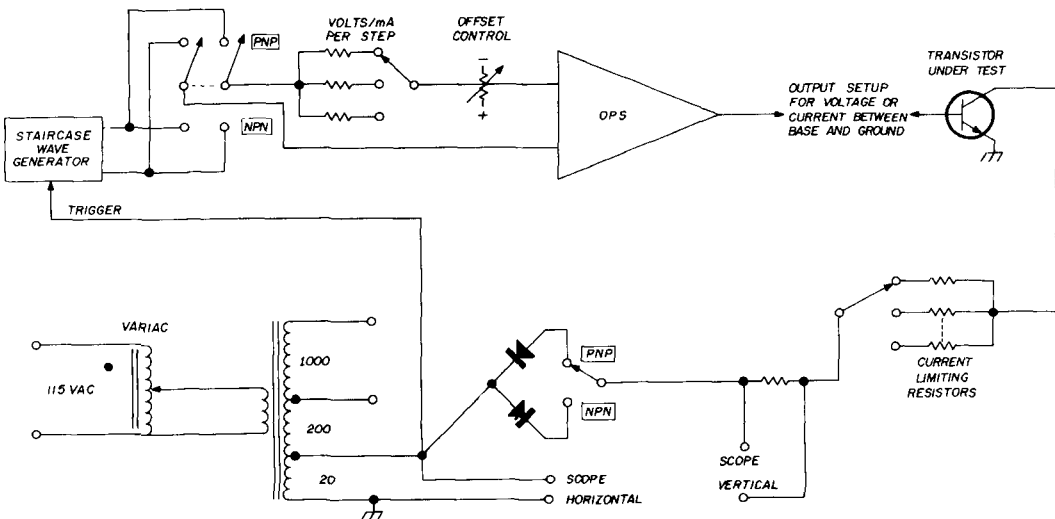

fig. 11. A linear ramp generator results if the capacitive load, C, is discharged automatically.

load is used, the capacitor will be charged with a constant current, giving a linear increase in output voltage. By providing a method of automatically discharging the

fig. 12. Semiconductor curve tracer. Bipolar output of OPS allows it to be used with npn or pnp transistors.



capacitor, a linear ramp generator is created, fig. 11.

semiconductor curve tracer

An application where constant current, constant voltage, and programm-

fig. 13. Inductor or transformer analyzer. Core saturation is indicated when the secondary voltage decreases or becomes nonlinear.

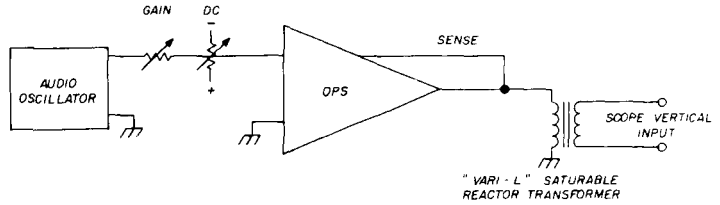

ability are necessary is in a curve tracer (fig. 12). Obtaining a single curve is possible by ordinary methods, but it's more useful to have a family of curves at different base currents or voltages. Due to the bipolar nature of the supply, it can be used for npn and pnp resistors, including power transistors.

inductor-transformer analyzer

Other testing applications might include determining characteristics of audio

typically regulate only within a degree or two. Put a thermistor in the crystal oven (fig. 14) and connect it in a bridge arrangement so that the bridge is nulled when the thermistor is at the proper temperature. Connect the OPS to detect the null voltage. Connect the output directly to the oven winding (disable the thermostat), and you will have a proportionally controlled oven with a temperature stability at least an order of magnitude better than a thermostat.

fig. 14. Proportional temperature controller. The ops provides better control than a thermostat.

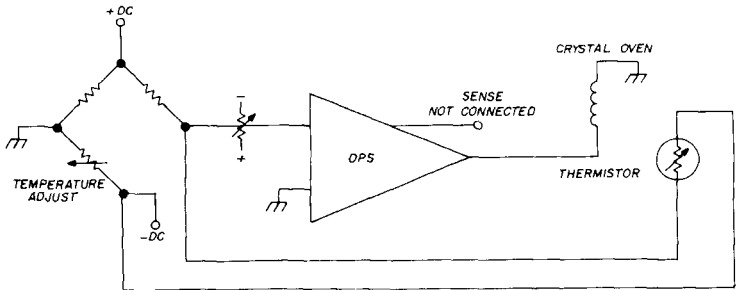

inductors or saturable reactors (fig. 13). Apply a small ac voltage to the input of the supply, connect the output to a transformer primary, and slowly increase the dc output. When the output voltage at the secondary decreases or becomes nonlinear, the core is saturating. This is a good way to find out the current rating of modulation transformers. This hookup can also be used to sweep variable inductors¹, while providing a constant bias.

tracking power supply

Power supplies of equal positive and negative voltage are often required for IC experimentation. Since the operational power supply is an inverting amplifier, it can be adjusted to give a gain of -1. Connected to the output of an ordinary supply, it will give an equal and opposite output voltage that will track the voltage of the original supply. Fig. 15 is an example.

conclusion

After you've built your OPS, you'll be quite familiar with two of the most popular IC's on the market. You'll also be able to boast to your hi-fi-nut neighbor

that you have an amplifier with better bass response than his.

I'd like to acknowledge the help of Steve Schwartz, WA2YDN, who made the photographs accompanying this article.

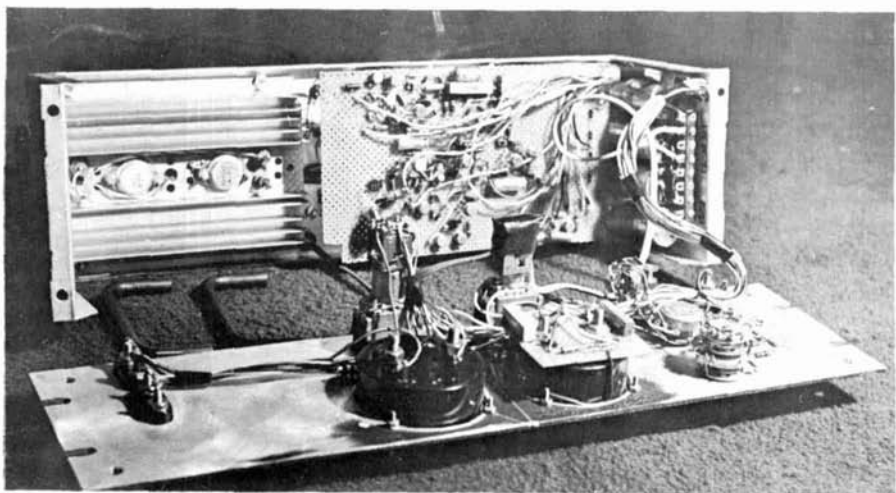

Inside view of the OPS. The perforated board behind the voltage meter contains the meter multipliers. The heat sink hold the two output transistors and the rectifiers.

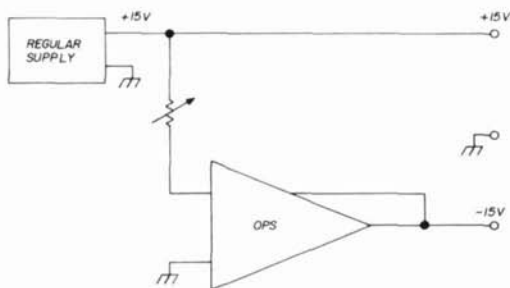

fig. 15. Tracking power supply. An equal and opposite output voltage from the OPS will follow that of the power supply being tested.

reference

¹Robert M. Brown, "Solid-state Current Controlled Tuning", *ham radio*, January, 1969, p. 38.

bibliography

Handbook of Operational Amplifier Applications, Burr-Brown, Inc.
Handbook of Operational Amplifier Active RC Networks, Burr-Brown, Inc.
Linear Integrated Circuits Applications Handbook, Fairchild Semiconductor, Inc.
DC Power Supply Handbook, Application Note 90, Hewlett-Packard.
Power Supply Handbook, KEPCO, Inc.
Operational Amplifiers, Radiation, Inc.

ham radio

next month, a special antenna issue featuring:

triangular beam antennas
multiband dipoles
80-meter beam
antenna matching techniques
integrated swr/power meter

antenna tuner design
receiving antennas
the isotropic antenna
swr alarm circuits
cubical quads



**MXX-1 Transistor
RF Mixer \$3.50**

A single tuned circuit intended for signal conversion in the 3 to 170 MHz range. Harmonics of the OX oscillator are used for injection in the 60 to 170 MHz range.

Lo Kit 3 to 20 MHz
Hi Kit 20 to 170 MHz
(Specify when ordering)



**SAX-1 Transistor
RF Amplifier \$3.50**

A small signal amplifier to drive MXX-1 mixer. Single tuned input and link output.

Lo Kit 3 to 20 MHz
Hi Kit 20 to 170 MHz
(Specify when ordering)



**PAX-1 Transistor RF
Power Amplifier \$3.75**

A single tuned output amplifier designed to follow the OX oscillator. Outputs up to 200 mw, depending on the frequency and voltage. Amplifier can be amplitude modulated. Frequency 3,000 to 30,000 KHz.



**BAX-1 Broadband
Amplifier \$3.75**

General purpose unit which may be used as a tuned or untuned amplifier in RF and audio applications 20 Hz to 150 MHz. Provides 6 to 30 db gain. Ideal for SWL, Experimenter or Amateur.

For The Experimenter!

International EX Crystal & EX Kits

OSCILLATOR / RF MIXER / RF AMPLIFIER / POWER AMPLIFIER



Type EX Crystal

Available from 3,000 to 60,000 KHz. Supplied only in HC 6/U holder. Calibration is $\pm .02\%$ when operated in International OX circuit or its equivalent. (Specify frequency)

\$3.95



OX Oscillator

Crystal controlled transistor type. Lo Kit 3,000 to 19,999 KHz
Hi Kit 20,000 to 60,000 KHz
(Specify when ordering)

\$2.95

Write for complete catalog



CRYSTAL MFG. CO., INC.
10 NO. LEE • OKLA. CITY, OKLA. 73102



simple speech processor for ssb

Anyone who listens critically to amateur ssb stations will notice many signals with poor audio quality. Even though the transmitters putting out these signals are well designed, distortion will occur if transmitter design limitations are exceeded. Such distortion is caused by attempting to exceed peak available power or maximum average power.

This article explores methods for obtaining maximum transmitter effectiveness, while maintaining basic power limitations.

modulation control

In many commercial stations, volume compressors are used between the microphone and transmitter. The compressors are of two types. One operates as an average program level control. It has relatively long time constants to maintain output at optimum average modulation level. The other, operating as a peak limiting device, has shorter time constants to prevent over-modulation on peaks.

Optimum average modulation control and peak level control also apply to amateur transmitters. Regardless of peak envelope power or the type of compressor, limiter or alc circuit used, all ssb

transmitters are power limited by output tube plate dissipation and, of course, the power supply's capability and regulation.

If an ssb transmitter is rated at, say, 500 watts peak envelope power, then with no speech processing circuit the ratio of peak-to-average power would be of the order of 5:1 for normal speech. Average power input would be about 100 watts. With an efficiency of 60 percent, about 40 watts would be dissipated in the final amplifier tubes. If these tubes have a rated plate dissipation of more than 40 watts, then some increase in average power would be permissible if it could be obtained without increasing peak envelope power. This can be done with a speech processor that controls the ratio of peak-to-average power in the audio signal.

volume compressors

A volume compressor is a form of automatic gain control. Agc is obtained by rectifying a portion of an audio amplifier's output; the rectified output then controls audio gain when fed back to circuits preceding the audio amplifier. Volume range is thus automatically controlled as a function of input signal level.

In a volume compressor, volume range

R. Lee Price, K6PHT, 1512 Oberlin Avenue, Thousand Oaks, California

is automatically reduced, and the average power level of the speech signal is increased relative to its peak. In a peak-limited ssb system, such a circuit can be used to increase average modulation without a corresponding increase in peak modulation level.

Because the speech envelope rises and falls, the rate of the speech envelope variation is referred to as the "syllabic rate." This occurs between about 0.5 and

agc that will increase average power level and readability through noise, before the accompanying wave-form change (distortion) becomes objectionable, depends on received signal-to-noise ratio.

peak clippers

A second type of circuit for increasing average modulation level is the peak clipper or "hard limiter." This has very short attack and decay time constants.

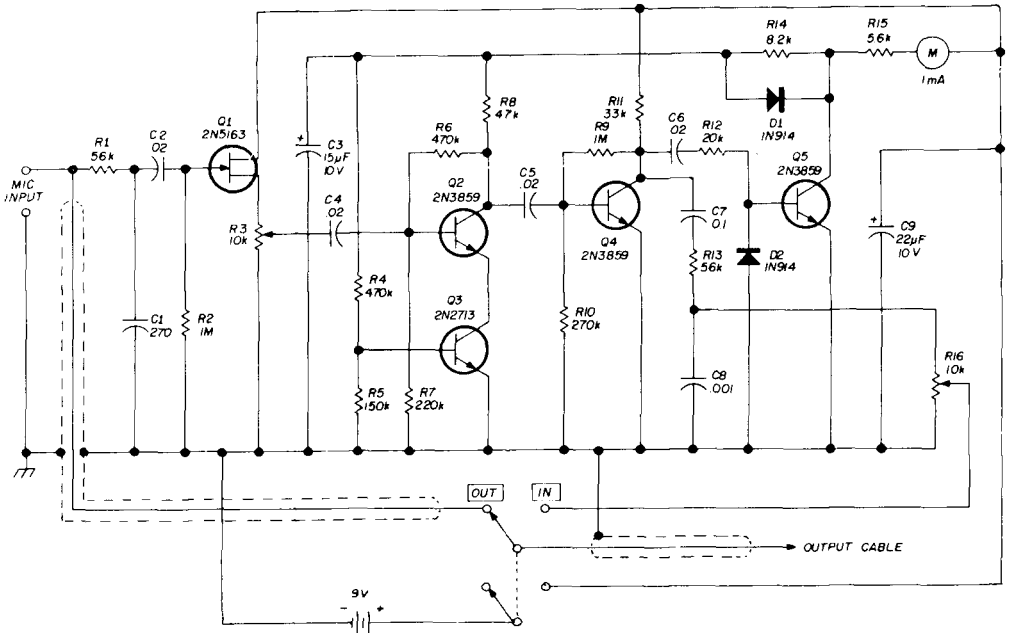

fig. 1. Schematic of battery-operated agc audio signal processor. Distortion is less than 3 percent on a 1-kHz sine wave with 14 dB compression.

25 Hz, with an average of about 5 Hz. The speech envelope variation is, in effect, a form of amplitude modulation. The amount of a-m is of the order of 25:1, or 28 dB for average continuous speech. Much of this a-m can be removed without greatly effecting speech intelligibility. However, if too much of the syllabic rate variations are removed, low-level syllables and breath sounds become excessive and speech has an unnatural sound.

An oscilloscope will show that compression causes a change in speech waveform, which is interpreted by the ear as distortion. The amount of compression or

When used at audio frequencies, distortion is introduced because the audio waveform peaks flatten. Although most of the distortion can be removed with low-pass filters, we are left with intermodulation distortion products within the audio passband. This distortion tends to reduce intelligibility.

Peak clippers or limiters have been used effectively at radio and intermediate frequencies. If carrier frequencies are properly chosen, harmonic and intermodulation distortion products, resulting from flattening of the rf signal peaks, will fall outside the rf or i-f passband and can be removed with filters.

alc circuits

The alc circuits included in most ssb transmitters are compressors operating at the output radio frequency. Single-sideband transmitters use frequency converters to translate speech frequencies to a band of radio frequencies. After translation, the ssb signal is linearly amplified. Examination of the ssb rf signal shows a variation in amplitude at the syllabic rate not unlike the original speech waveform envelope. The alc circuit has a compression threshold near maximum modulation to prevent flat-topping. Because of this high threshold, alc circuits don't have a dynamic range of more than a few dB, which isn't sufficient to compensate for large variations in audio signal level.

agc speech compressor

An effective speech processor is an agc amplifier inserted in the microphone circuit. Not only does the processor maintain optimum modulation level; it is particularly useful when the transmitter is being modulated by someone other than an experienced operator. In phone patch work, for example, phone line signal levels vary between persons and from one connection to the next. An agc speech processor between phone patch and transmitter will equalize audio signal level variations.

After much experimentation, I developed the agc process shown in fig. 1. Its features include:

1. Simplicity and low cost.
2. Battery operation. Battery life should exceed 200 hours.
3. Low distortion: less than 3 percent on a 1-kHz sine wave with approximately 14 dB compression.

circuit description

Q1, an fet connected as a source follower, provides high input impedance. This input circuit allows almost any type of microphone to be used. Threshold control R3 provides proper signal level to the agc amplifier despite output from different microphones.

Q2's gain is controlled by a combination of two effects. As signal level increases above agc threshold, agc rectifier/amplifier Q5 starts to conduct. Its collector current decreases the voltage on agc capacitor C3, which decreases Q2's collector current. Q2's gain is proportional to collector current, so amplifier gain is reduced. At the same time, the collector impedance of Q3, which is the emitter degeneration for Q2, increases since it is also biased from C3; thus Q3's bias is decreased. These two effects, decreasing collector current and increasing emitter impedance, provide a net

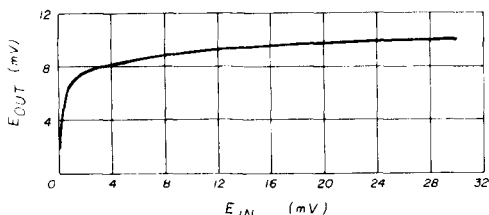

fig. 2. Agc response with speech processor threshold set at about 2 mV.

gain reduction without an appreciable change in Q2's collector voltage. Thus no transient "thump" is noticeable in the amplifier's output.

Q4 is a linear, constant-gain output amplifier that also provides proper threshold voltage for Q5. R12 isolates Q4 from Q5 so that Q4's output waveform won't be distorted from nonlinear loading by Q5. R1, C1 make up an rf filter for the microphone input, and R13, C8 constitute a low-pass filter for the output signal.

specifications

The performance of this circuit has been carefully measured with the following results:

frequency response (Hz)	300-3000
maximum compression (dB)	26
attack time (ms)	10
decay time (ms)	100
distortion (percent)	3*

* On 1 kHz sine wave at 14 dB compression.

operation

The threshold and output-level controls, R3 and R16, should be set as follows. Set the function switch to the OUT position, and set transmitter gain controls for proper modulation level. Set the function switch to the IN position and set output control R16 to minimum. Advance threshold control R3 until meter M1 kicks up to about half scale while speaking into the microphone in a normal voice. Turn up R16 until full modulation is again obtained. Further adjustment of transmitter gain control shouldn't be

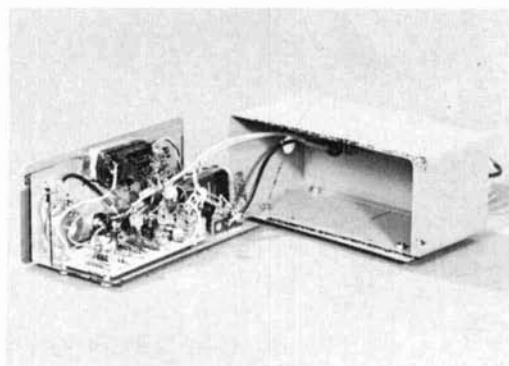

Speech processor showing parts layout.

necessary with the agc amplifier either IN or OUT. A good rule for adjusting the amount of agc action by setting the threshold control is to use no more agc compression than necessary to obtain reliable communication. If signal-to-noise ratio is high, an excessive amount of compression will make speech sound unnatural. On the other hand, if signal-to-noise ratio is low, additional agc compression will raise the average modulation level.

use of panel meter

An advantage of this circuit is that the amount of agc in use is always visible on the meter. The threshold control may be adjusted for existing conditions by watching the meter. If signal-to-noise ratio is poor, an increase in threshold and agc level will provide better intelligibility.

A low threshold setting is advisable under strong signal conditions. The plot of **fig. 2** shows agc action with the threshold set at about two millivolts.

transmitter output limitations

The object of speech processing circuits is to raise average power level. Therefore it's important that your transmitter and its power supplies operate at the resulting higher average power level. If your transmitter is limited by peak power level, then a speech processor might improve your signal's readability by increasing average power level. If your transmitter's output is limited by average plate dissipation of the final tubes, power supply, or both, there's little advantage in attempting to increase the ratio of average-to-peak power.

other considerations

Many of the ssb transceivers on the market use TV-type sweep tubes as rf power amplifiers. It is well to remember that, although these tubes may be capable of quite high *peak* power, their *average* plate dissipation may be quite low. This limitation should be carefully considered before expecting improvement from speech processing circuits. Also, good air circulation is essential to proper operation of these power amplifiers. An efficient cooling system, with adequate space around the amplifier, is good insurance against overheating.

In conclusion, I'd like to re-emphasize that improvement in intelligibility can be obtained with speech processors when properly used, but rf power amplifier tube plate dissipation is still a limiting factor.

bibliography

¹H. G. Collins, "Ordinary and Processed Speech in SSB Application," *QST*, January, 1969, pp. 17-22.

²"Radio Communication Handbook," RSGB, 4th edition, pp. 9.25-9.30.

³"Radio Handbook," Editors & Engineers, 17th edition, pp. 297-304.

⁴Keith Henney, "Radio Engineering Handbook," McGraw-Hill, New York, 1959, pp. 19-72, 19-73.

ham radio

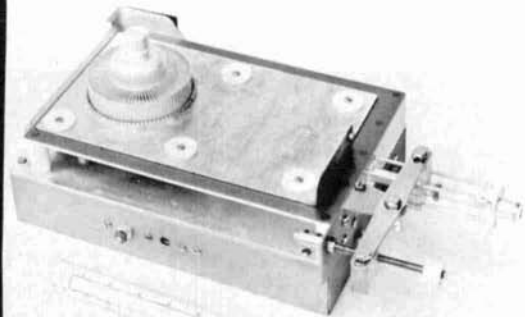

two-kilowatt linear for two meters

A high-performance
stripline amplifier
tailored for
the Henry Radio 2K
power supply

A previous article in *ham radio* described a 2-kW stripline amplifier for 150 MHz.¹ It was designed to conduct proof tests on the new Eimac 3CX1000A7 high- μ ceramic triode. As pointed out in the article, the amplifier can be adapted to two-meter operation.

We decided that this amplifier, built into the Henry 2K cabinet, would make a neat and compact two-meter package. With this in mind we obtained a 2K power supply, amplifier cabinet, and a set of panel meters.* The amplifier's plate line and output coupling system were modified, and metering and control circuits were added to accommodate the 2K supply. The photo of the completed unit shows the result: a full-legal-power linear that performs as well as it looks.

This article contains information to allow duplication of the amplifier by the serious vhf enthusiast.

design

A schematic of the amplifier appears in **fig. 1**. The tube operates in a conventional grounded-grid circuit. Plate and grid current are measured in the filament return leads. An 18-volt zener in the filament return sets the desired idling plate current. A reflectometer circuit is included to aid in tuneup.

The amplifier is neutralized by moving
*Henry Radio Stores, 11240 West Olympic Blvd., Los Angeles, California 90064.

Bob Sutherland, W6UOV, Ray Rinaudo, W6ZO, Merle Parten, K6DC

the self-neutralizing frequency of tube and socket from 105 to 145 MHz. The control-grid lead inductance is reduced by modifying the tube socket (see photo). The 1/8-inch cylindrical spacers and 1/16-inch rectangular spacers are re-

socket stack; then standard nuts are used.*

cathode circuit

A T-network matches the 50-ohm drive line to the input impedance of the 3CX1000A7, which is 42 ohms.

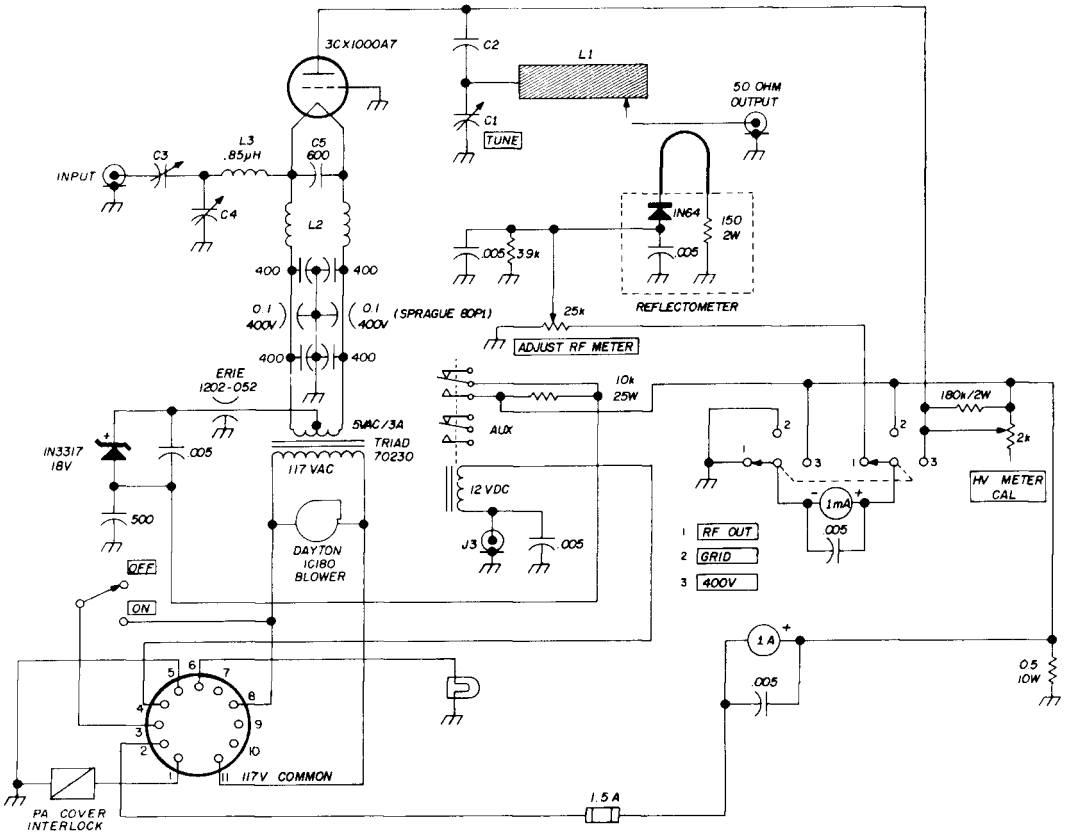

C1, C2 Part of strip line assembly (see detail drawing available from Eimac)

C3 35 pF piston, set to about 3.8 pF (Johanson type 803)

C4 Approximately 6.5 pF. 1" diameter plates on lead screw (set to about 1.4 pF)

C5 600 pF; six 100-pF capacitors in parallel.

L1 Part of strip-line assembly (see detail drawing available from Eimac)

L2 9 turns no. 8 enameled, 3/4" ID, bifilar wound 4 turns no. 14, 3/8" ID.

fig. 1. Complete circuit diagram of the kilowatt amplifier for 144 MHz.

moved. The latter spacers have threaded holes for the long machine screws that hold the socket stack together. To secure the stack in the modified socket, the long screws are reversed and inserted into the chimney mounting holes, chassis, and

The modified Eimac SK-870 socket is mounted directly on to the chassis deck, *This assembly, plus that of the entire plate-circuit resonator and output coupler are detailed in a scaled drawing available from Eimac, 301 Industrial Way, San Carlos, California 94070.

putting the control grid at dc ground. The grid current is metered in the cathode return lead. The photo of the chassis underside shows the filament choke and input matching network.

plate circuit

Note the two sheet-metal plates mounted on the right end of the tuned circuit in the photo showing the top view of the plate resonator. These plates are part of the tuning capacitor, C1; one plate is movable from the front panel by an eccentric drive. A padding capacitor is mounted at the open end of the plate line. The mechanism for changing the loading (at left in the photo) is discussed later.

A metal trough runs along the cabinet wall and into the area between the front panel and the subpanel to provide shielding for metering and control wires.

The photo of the completed amplifier shows the eccentric drive, made of Rexolite 1422, which moves one plate of tuning capacitor C1. The capacitor plate is made of beryllium copper so it will return to its original position as the eccentric drive is turned. A lip on one end



The complete amplifier is a look-alike to its high-frequency cousin, the Henry 2K.

of the movable plate bears against the tuning eccentric.

The shoulder washers that secure the upper plate-line sandwich of copper and Isomica were machined from Teflon rod stock. The Isomica was obtained from Minnesota Mining and Manufacturing

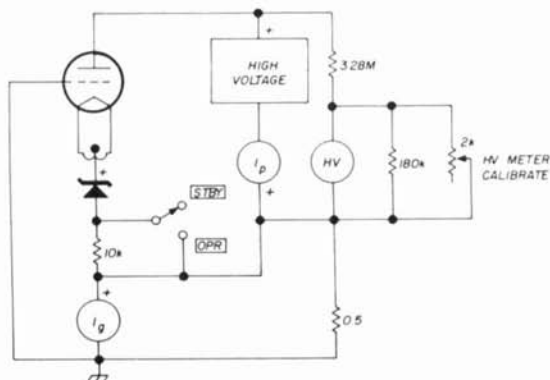

fig. 2. Basic metering circuit used in the amplifier.

Company. Probably other dielectrics such as Teflon and Mylar could be used but Isomica has a dielectric constant between 4.5 and 5 — about twice that of Teflon; Mylar has a dielectric constant of about 3.1.

output loading circuit

The output loading circuit consists of a sliding tap on the plate line coupled to a 50-ohm, five-wire transmission line. The four outer conductor rods are fixed. The inner conductor is telescoping brass tubing, which allows loading adjustment by varying the position of the power take-off point along the plate tuned circuit. The inner conductor is 0.375-inch O. D. brass tubing, which is soldered at one end to the output coaxial receptacle. A second piece of brass tubing, 0.382-inch I. D., is telescoped over the fixed piece. To make good electrical

Al Roach, W6JUK, of Dymond Electronics, 515 Blackstone, Fresno, California 93701, is presently planning to market a 144-MHz rf deck very similar to the one in this amplifier, including the strip line, 3CX1000A7 tube and SK-870 socket. If there is sufficient interest he may offer a complete amplifier, including power supply, blower, metering and cabinet. If you're interested, write directly to him.

contact, finger stock backed up by a coiled spring is soldered to the larger conductor. The other end of the 0.381-inch I. D. tubing is inserted into a Teflon block, which slides along the four outer conductor rods. Finger stock is mounted on the Teflon block and

table 1. Operating conditions for the 2-kilowatt amplifier.

	cw	ssb
plate voltage	2900 volts	2710 volts
plate current (zero signal)	32 mA	32 mA
plate current (single tone)	332 mA	690 mA
amplifier plus driver		
input power	1000 watts	2000 watts
grid voltage	-18 volts	-18 volts
drive power	25 watts	82 watts
filament voltage	5 volts	5 volts
filament current	33 amps	33 amps
power output	500 watts	1120 watts

shorting block. The four outer conductor rods are threaded and screwed into tapped holes on each side of the shorting block.

performance

The amplifier operates over the 144-148 MHz band under the conditions shown in table 1. No intermodulation measurements were made, but previous experience indicates that third-order products will be 32 dB below one tone of a two-equal-tone signal.

references

¹Robert I. Sutherland, W6UOV, "Design Data for a Two-Kilowatt VHF Linear," *ham radio*, March, 1969, p. 6.

The Eimac SK-870 socket before modification, below. Washers were removed to increase tubes self-neutralizing frequency, upper.

Input circuits showing T-network and bifilar-wound filament choke.

soldered to the five-wire transmission line center conductor. The finger stock makes contact with the inside surface of the top slab of the plate tuned circuit, providing variable contact for adjusting the load. The center conductor rides in a Teflon sleeve bearing where the transmission line passes through the plate resonator

Completed amplifier. Blower and filament transformer on reverse side protrude into large empty space in top of cabinet.

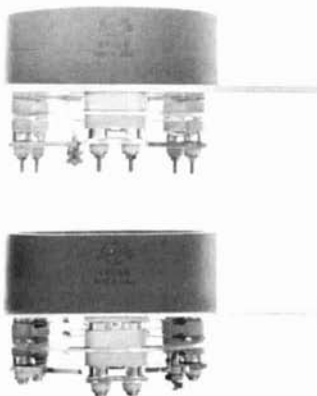

an electronic thermometer

A simple
but effective instrument
that can be built
in just a few hours

A forward-biased silicon diode has a virtually constant negative temperature coefficient. The voltage across it drops about two millivolts per degree Centigrade (depending on the diode) over a wide temperature range.

This property has been known for years but has seldom been used for temperature measurement because of the complexities of the dc amplifier required for low drift and calibration stability. The

fig. 1. Circuit for the electronic temperature indicator. The LM301A is a very stable dc amplifier.

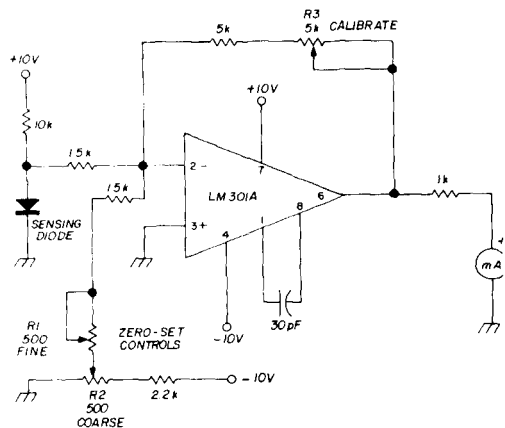

James Goding, VK3ZNV

availability of inexpensive IC operational amplifiers has changed the picture considerably.¹

The National Semiconductor LM301A operational amplifier, used in this circuit, costs less than six dollars. Its gain depends almost entirely on the feedback and input resistors, and the circuit is very stable.

design

The electronic thermometer circuit is shown in fig. 1. The difference between the input currents to the op amp (i. e., currents through the two 1.5k resistors) is amplified and presented to the meter.

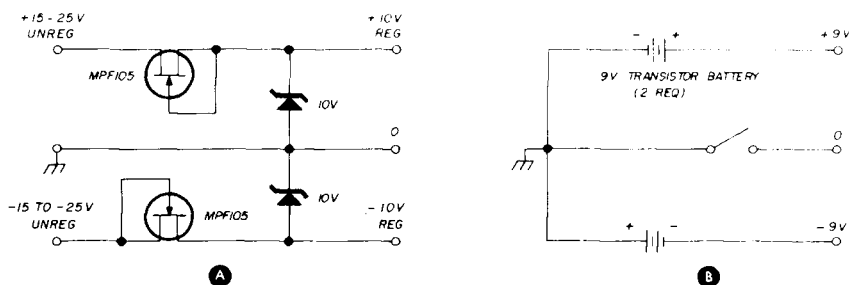

fig. 2. Regulated power supply for the thermometer, A. Circuit in B may be used as an alternate for preliminary checks.

This current difference is set to zero at 0° C by R1, R2; thus the meter indication is proportional to the temperature of the sensing diode. The calibration control, R3, sets the amplifier gain to suit the temperature coefficient of the diode.

power supply

The instrument requires regulated +10 and -10 volts. Current drain is only about two milliamperes. A simple method of obtaining stable voltages is shown in fig. 2A. A couple of inexpensive 9-volt transistor radio batteries, connected as shown in fig. 2B, may be used for initial check-out of the thermometer. However, a regulated supply should be used for calibration and operation. The regulation of

a battery supply isn't too dependable, especially after prolonged use when battery internal resistance increases.

calibration

The zero point must be calibrated first. Place the sensing diode in melting ice, then adjust the zero-set pots for zero meter indication. Place the diode in boiling water, and adjust calibration pot R3 for full-scale meter reading. Bubbles of steam may cause the meter to fluctuate, but this can be remedied by allowing the water to cool until it just stops bubbling. The water temperature will then be about 99°C.

installation

The instrument is now ready for use. The sensing diode may be placed remotely from the instrument. Long leads to the diode will have little effect on calibration. Thus the instrument is useful for measuring temperature in inaccessible places.

A suggested application would be a monitor for the TV sweep tubes used in many modern transceivers. These tubes can get pretty hot during prolonged key-down conditions in the cw mode.

reference

¹Don Nelson, WB2EGZ, "What's This We Hear About Op Amps?", *ham radio*, November, 1969, pp. 6-23.

ham radio

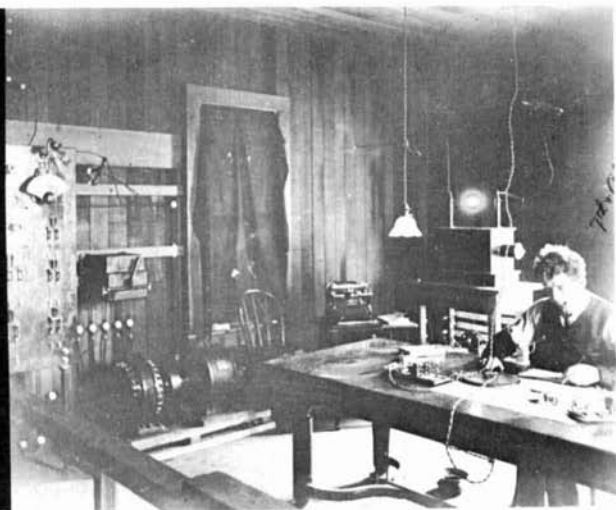

Inside the PW station in Los Angeles, August 1903; Mr. Krenke on watch. The knife switches and "bug eye" meter were typical of a powerful wireless plant.

catalina wireless

1902

Another glimpse
into the early days
of radio
by an old timer
who knew
the old timers...

Researching early wireless history is a part of ham radio I enjoy very much. It's a real challenge, because many events pertaining to new installations were not recorded in print. Newspapers didn't give much coverage to new wireless plants, probably because they were considered just another business venture without much news value.

Tracing the history of wireless communication calls for detective skills and infinite patience. To find really early information, one must talk to the oldest operator one can find, who might have talked to the oldest operator in his time. This takes a lot of digging and leg work, but results are rewarding if one has a soft spot in his heart for the early wireless pioneers.

Anyone who operated one of the very early stations is now nearing the century mark. He would be called an OOOT, or

Ed Marriner, W6BLZ

Olde, olde, old timer. In descending order of venerability, early operators might be classified thus:

OOOT	1900 - 1910
OOT	1910 - 1920
OT	1920 - 1940*

detective work

One of the earliest wireless circuits I'd heard about was established by the Pacific Wireless Telegraph Company around the turn of the century. It was between

work in cross-country communications on the "short" waves. Howard has since passed away, but he provided me with some good clues about the old PW station and some of the operators. As a boy, Howard used to hang around the PW station at 7th and Alameda in Los Angeles. He recalled a PW operator by the name of A. F. Krenke, who gave generously of his time and knowledge to help 6EA get started in wireless.

Howard also remembered that Mr. Krenke had moved to San Diego, where he operated a station for PW until about



PW technicians winding a helix coil for the Mt. Tamalpais station; Mr. Krenke at far left. Cloth stacked in corner was applied over each layer of wire and coated with shellac. Process was not unlike that used for making today's surfboards with fiberglass.

Los Angeles and the city of Avalon on Catalina Island, which is about 30 miles off the California coast.

My quest for historical data on this installation took me through the Los Angeles Times' morgue, the public library, and the Avalon Chamber of Commerce. As I said, nothing of significance was in print so I kept looking.

The trail finally led to Howard Seefred, 6EA. Historians will recall 6EA's contributions to the early ARRL relay

*The nonlinearity of the time scale after 1920 reflects the growth of the state of the art.
Editor.

1916. With this information, I contacted old-time Navy operators and early hams in the area in an attempt to find Mr. Krenke. As if by a miracle he was located, and with a steady hand he described his part in the drama of early wireless in Southern California. This is his story.

early circuits

The Marconi circuit between Catalina Island and Los Angeles was installed in 1902. The power of the press was augmented by that of the 5-kW straight gaps of the PW stations. News items transmitted over this circuit were published in

the Avalon paper. The Jefferies-Fitzsimmons fight results, for example, appeared in print hours before the news arrived by steamer from the mainland.

During the first few years of operation, the mainland PW station was located at San Pedro (15 miles or 15 minutes via the freeway today from downtown Los Angeles). In February 1905, the San Pedro plant was moved to 7th and Alameda after it was determined that messages could be sent the extra distance.

more detective work

The first criminal case to be solved with the aid of wireless was recorded during the first year of operation of the PW circuit. Seems that two fellows left Avalon on the steamer with the cash and some liquid goods from the Hotel Metropole bar. The hotel manager, anxious to try the new wireless (and retrieve the loot), sent a message to the San Pedro police department.

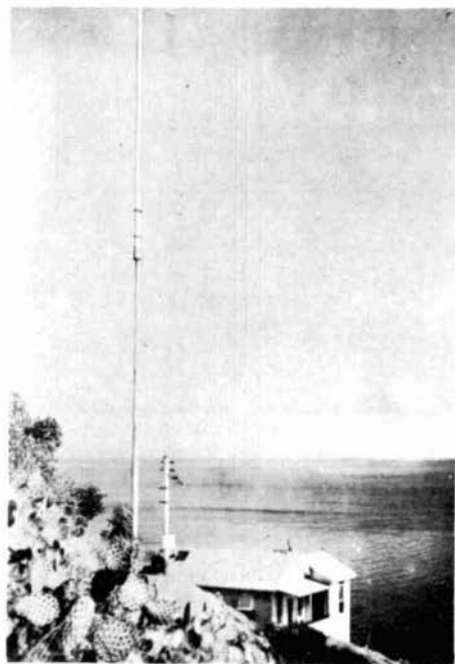

Catalina Wireless, 1903. It's still a DXer's dream location. Mast was 70 feet high and supported a Marconi antenna.

The San Pedro police were waiting at the dock when the steamer arrived from Avalon. The culprits were apprehended, much to their amazement and chagrin. The cash was returned to the hotel manager, but the bottled goods somehow disappeared en route. In any event, this seems to be the first recorded evidence of public service by wireless telegraphy.

help wanted

During this period, Mr. Krenke was a telegraph operator for the Southern Pacific Railroad at the Lone Palm Tree Watering Station (now known as Palm Springs).

Mr. Krenke went to Los Angeles shortly after the robbery and was fascinated by the excitement of wireless' contribution to law enforcement. Such events helped to increase business for PW, and they were looking for another operator. Mr. Krenke applied for the job and was assigned to the Avalon station, where he worked for about two years.

catalina wireless

The Avalon station was on a hill above the dance casino (now the St. Catharine Hotel). Operating technique wasn't as polished as it is today. At the end of a transmission, for example, the operator had to shut down the motor generator so he could copy the message from Los Angeles. If he missed a word or two (which was not uncommon), he had to start up the gasoline engine that ran the generator so he could ask the Los Angeles station for "fills", as they were called. Such was break-in operation in those days. It was slow — but who hurried in 1903?

the wireless news

A synopsis of the Los Angeles Times was transmitted to Avalon each day, amounting to about 600 words of press. The news, hot off the crudest of receivers, was typeset and printed in Avalon. The paper was called the "Wireless News" and sold for ten cents. A mint copy of this publication would be worth a great deal today.



Mr. Krenke, chief operator, Catalina Wireless, 1903. Blackboard at left announced incoming messages for the locals.

business expansion

The Pacific Wireless Telegraph Company had big plans. Management made the decision to install a powerful station on Mt. Tamalpais, near San Francisco. The idea was to send messages all the way to Honolulu, an ambitious dream in 1906.

A construction crew from PW first installed a station in the Merchant's Exchange building, with offices on the 14th floor, in downtown San Francisco. Then a station and antenna tower were installed on Mt. Tamalpais.

On April 18th, 1906, an earthquake rocked San Francisco. The tower on Mt. Tamalpais came down, and the station was completely wrecked. This dashed the

*This was supposedly the result of work by one Charles Hatfield, an itinerant rainmaker, who was hired by the San Diego City Council to end a long drought. Hatfield never collected his \$10,000 fee, because the flood was considered an "act of God". Litigation by Hatfield's descendants is still pending in San Diego courts.

hopes of the company that tried so hard — and the date of wireless communication between California and Hawaii was set back many years.

wireless san diego

Out of the San Francisco wreckage of 1906 emerged a new wireless company. It was called United Wireless and Telegraph, and was founded in 1908. Mr. Krenke worked for UW at their station in San Diego. The UW plant was installed on the Granger Building at 5th and Broadway, San Diego. This venture didn't last long, and Mr. Krenke again found himself out of a job. He delivered groceries for awhile to make ends meet, then he heard rumors of a new wireless station to be installed in San Diego. But I'll let Mr. Krenke finish the story.:

"I'd heard that the Federal Wireless and Telegraph Company was interested in establishing a station in downtown San Diego. I considered the possibility of the U. S. Grant Hotel as a site. The hotel manager, a Mr. Holmes, was sympathetic to the idea, and we wrote to the Federal Wireless Company in San Francisco.

"To make a long story short, I was hired by FWT's chief engineer and was put in charge of the station. I installed the antenna system. The transmitter was a Poulsen arc, which was powered by a 500-watt dc generator. I hired a messenger boy and was in business.

"After about five years (I'm not sure of the date, but I think it was 1915) a terrific storm hit San Diego. Heavy rain caused a dam to break, which created a flood that destroyed thousands of dollars worth of property.* San Diego was isolated except for the wireless station. During this terrible storm, my station handled Western Union and Postal Telegraph traffic in addition to our regular work. I stayed at the key for three days.

"There's little left to tell. I was sworn into the U. S. navy in 1917 and operated radio NPL on Point Loma. After World War I, I worked as a civilian operator in San Francisco, ending a half century as a wireless operator."

ham radio

variable bandpass audio filter

One solution to
the receiver
selectivity problem
is this RC feedback system
featuring
variable bandwidth
to less than 50 Hz

Many articles have been written to provide a solution to the selectivity problem existing in some popular amateur transceivers and older receivers. Most of these designs use a passive LC filter employing surplus toroids in a resonant circuit. The filter is usually an add-on device connected in the audio circuit.

While this is an acceptable approach, it does have some disadvantages. The resonant circuit at audio frequencies is bulky, and it's difficult to obtain high Q for good selectivity without some ringing.

Selective filters using RC feedback to obtain high Q without ringing haven't appeared often in the amateur literature. This article presents an effective solution to the selectivity problem using RC feedback techniques and provides some theory on basic principles. If you'd rather skip the theory, you can build the circuit shown in fig. 6, plug it in, and enjoy excellent variable bandwidth in a filter centered at 500 Hz.

RC feedback networks

Passive elements in an appropriate circuit will yield voltage gain. Consider fig. 1, in which three resistors and three capacitors are connected in series-parallel. If $C1 = C2 = C3$ and $R1 = R2 = R3$, the network will resonate at a frequency $F_0 = 65/CR$, where C is in microfarads and R is in kilohms. Applying an ac signal to terminals 1 and 2, a signal loss will occur at terminals 3 and 4. But at F_0 , the signal at terminals 3 and 4 will be 180 degrees out of phase with the input signal. This is very important, as discussed later.

three-terminal analysis

If the signal at the output were 10 times less than the input signal, the network would have a loss factor of 10. Another way of saying this would be that the beta (as in transistors, for example) is

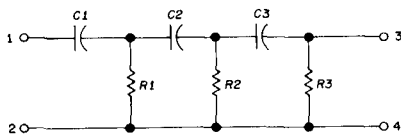
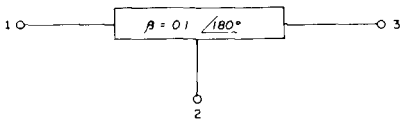

fig. 1. RC 180-degree phase-shift network.

Gary B. Jordan, 629 Manhattan Avenue, Hermosa Beach, California 90254

equal to 0.1 at 180-degree phase shift. The network could then be represented as in **fig. 2**, which is simply a three-terminal black box. If, as shown in **fig. 3**, a 10-V p-p signal were applied to the input, the output would be 1 V p-p precisely

fig. 2. Three-terminal equivalent of the RC network.



180-degrees out of phase with the input. When the input wave reaches a maximum, output would be minimum, and vice versa.

Now consider something quite interesting. If a voltmeter were connected across terminals 1 and 3 and we consider only one instant of time in the ac waveform of **fig. 3**, that instant will be

fig. 3. RC network input/output relationship.

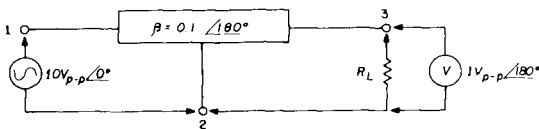

the precise point at which the input reaches a maximum of 10 volts and the output reaches a minimum of -1 volt, since the output is 180 degrees out of phase with the input. Looking at **fig. 4**, we see that input and output ac signals have been replaced by two batteries representing the selected instant of time. Hence, a 10-volt battery represents the peak input, and a 1-volt battery the phase-reversed output.

voltage gain

The really interesting feature is that a voltmeter connected across terminals 1-3 will indicate 11 volts. This is a higher voltage than either input or output because it is the *sum* of these voltages. For every point on the ac wave, the voltage across terminals 1-3 will always be greater

than that across terminals 1-2. The reason is that the phase shift causes the output at terminals 1-3 to be the sum of voltages from terminals 1-2 and 3-2. A voltage gain therefore exists at terminals 1-3 with respect to terminals 1-2.

To take advantage of this gain, we select 1-2 as the input as before, but take our new output from 1-3, as shown in **fig. 5**. Thus, we have created an ac transformer of sorts that has a voltage step-up, but at only one frequency: that at which 180 degree phase shift occurs.

RC audio filter

A selective audio filter may be created by connecting the phase-shift network around an amplifier so that the network's voltage gain is utilized. If the product of the amplifier gain, *K*, and the new network's beta, *B*, is greater than unity, the circuit will oscillate. However, if *K* is made less than unity, the circuit won't oscillate but will have an extremely high *Q* at the feedback network's resonant frequency. The system's bandpass will become narrower as the product of *B* and *K* approaches unity.

To implement this idea, it's necessary to find an amplifier with less than unity gain. An emitter-follower fills the bill quite well, since its *K* is 0.98 typically. **Fig. 6** shows the RC network connected in the voltage-gain mode around the emitter-follower. *R6* controls feedback to a point below where oscillation would

fig. 4. View of the network at one instant of time.

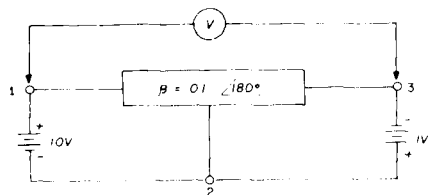

occur. Thus, *R6* provides a means of controlling bandwidth.

You might wonder what happened to the third resistor in the phase-shift network. It is still there, but as a virtual resistor composed of a parallel combina-

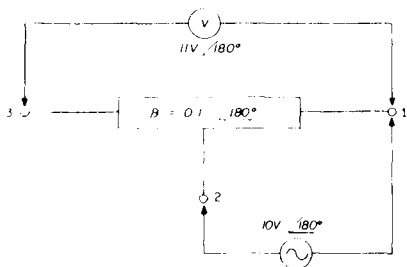

fig. 5. Reconnecting the input and output to yield voltage gain.

tion of all the resistance at the transistor base, and B times all the resistance at the emitter. In network notation, the virtual resistor consists of

$$R3 \parallel R7 \parallel B (R10 \parallel R8 + R9)$$

The bias is obtained through R7, which provides dc bias as well as a small amount of degenerative feedback for stability.

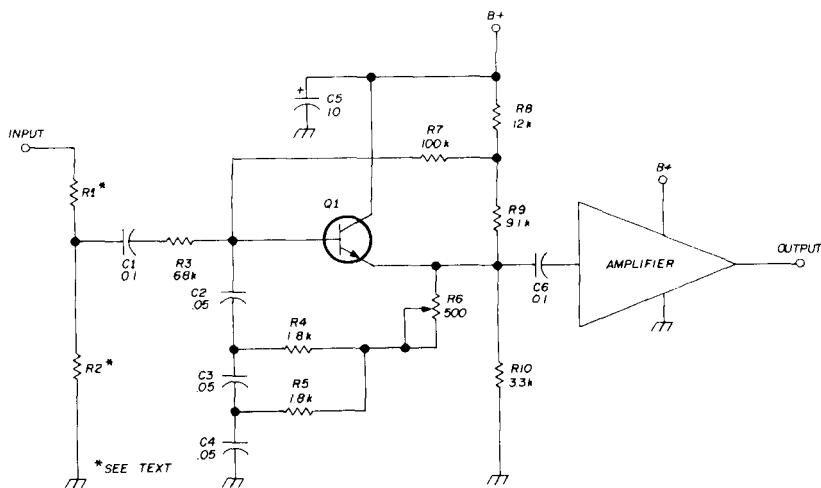

fig. 6. Variable bandwidth selective audio filter. Capacitor C5 is a tantalum electrolytic; other capacitors are disc ceramic. Transistor Q1 is any small-signal npn transistor. The amplifier can be any inexpensive audio amplifier IC.

the second amplifier

The amplifier shown as a block in fig. 6 may be any of the inexpensive, commercially available audio amplifiers in potted form, a microcircuit, or a simple home-built audio stage. Some amplifica-

tion is needed because the voltage at C1 must be kept to a few hundred millivolts p-p to avoid over-loading the circuit.

Higher inputs will cause some loss of selectivity. Resistors R1 and R2 may be selected to reduce the audio from, say, a receiver's headphone output to the proper level. Typical values of R1 and R2 would be about 2K and 200 ohms respectively.

construction and operation

Construction isn't critical, but care should be taken to separate input and output circuits, and the supply voltage should be well bypassed at audio frequencies. Typical supply voltage would be 6-15 volts dc; a 9-volt transistor battery could be used.

Varying R6 will allow a passband between several hundred Hz to less than 50 Hz for copying cw signals. If R6 is

operated near the shorted-out point, the circuit will oscillate.

Considering the circuit's simplicity and the excellent results, this seems to be an easy way to obtain audio selectivity for true single-signal reception.

ham radio

HAMMARLUND

DESK TOP LINEAR

well reared — works good up front - too!

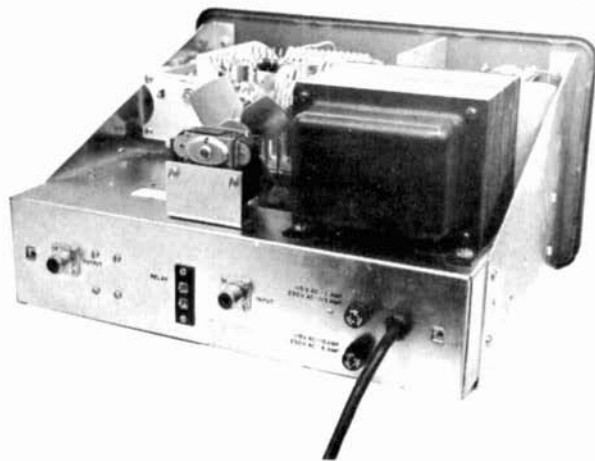

2 KW

PEAK POWER INPUT

HXL-1

linear amplifier

Hammarlund tradition demands quality one notch better than the rest!

So — you get . . .

. . . rugged, wide-spaced, industrial type tuning capacitors made by the most famous name in capacitors — Hammarlund!

. . . rigidly mounted "Hi Q," low loss tank coil for maximum power output!

. . . oversize power transformer specially designed to handle "peak power" requirements!

. . . no RF watt meter needed for proper tune up. RF output scale and linearity test provide all you need for tuning up your linear! Shows improper loading and overdrive!

. . . Pi-network output circuit for efficient power transfer to your antenna!

. . . high efficiency blower keeps final tubes cool for long operating life.

FEATURES

- Complete 80 through 10 meter coverage!
- Compatible with HX-50A or any 70-100 watt exciter!
- "Wide-band" grounded grid input circuit!
- "Instant power" — no warm up needed!
- Built in DC operated antenna relay for chatter-free operation.
- Circuits monitored by multi purpose meter.
- Solid state, long life power supply.
- Control circuitry compatible with most exciters.



The **HAMMARLUND**
Manufacturing Company Incorporated

A subsidiary of Electronic Assistance Corporation
20 BRIDGE AVENUE, RED BANK, NEW JERSEY 07701

These Facts Brought To You Straight From The Shoulder By The Hams At Hammarlund

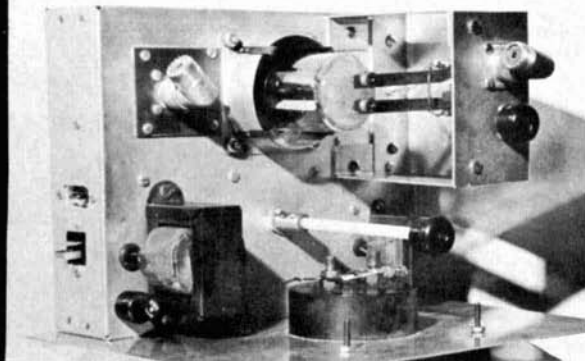

rf power amplifier

for

432 MHz

A design featuring
resonant-line
tank circuits
and class C or AB1
operation

If you would like to boost your signal on 432 MHz (and who wouldn't?), this amplifier will do the job with only 4 watts of drive. It provides 100 watts input on cw and ssb and 65 watts on a-m. A variable bias control allows instant selection of class C or AB1 operation. A type 5894 tube is featured. The 5894 performs well in the 400-MHz band and is available at reasonable cost from dealers in used uhf equipment.

the circuit

The tuned-circuit elements are conventional. A $\frac{3}{4}$ -wavelength grid tank and series-fed push-pull $\frac{1}{4}$ -wavelength plate tank are used. The circuit is shown in **fig. 1**. Bias can be varied from -60 to -28 volts for Class C or AB1 respectively. I've had no problems with parasitics or self-oscillation on either mode.

construction

A 9 x 7 x 2-inch chassis accommodates all components, including transformers and bias supply. Construction details for grid and plate lines, as well as for the

James W. Brannin, K6JC, 424 Anson Avenue, Rohnert Park, California 94928

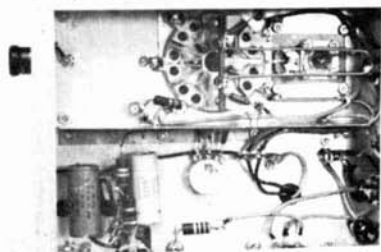

plate tuning capacitor and output link, are shown in fig. 2.

Shielded wire is used below chassis to minimize stray coupling. Coupling between input link and grid tank should be fairly close. The loops should be spaced about 3/16 inch.

The 5894 socket preferably should

the diode to a 0-200 microammeter. (If you use a 0-1 milliammeter, the pickup wire length will have to be increased to about six or eight inches.)

Decrease plate and screen voltage to about 300 and 150 volts, and tune the amplifier for maximum output into the 50-ohm load. Disconnect the dummy

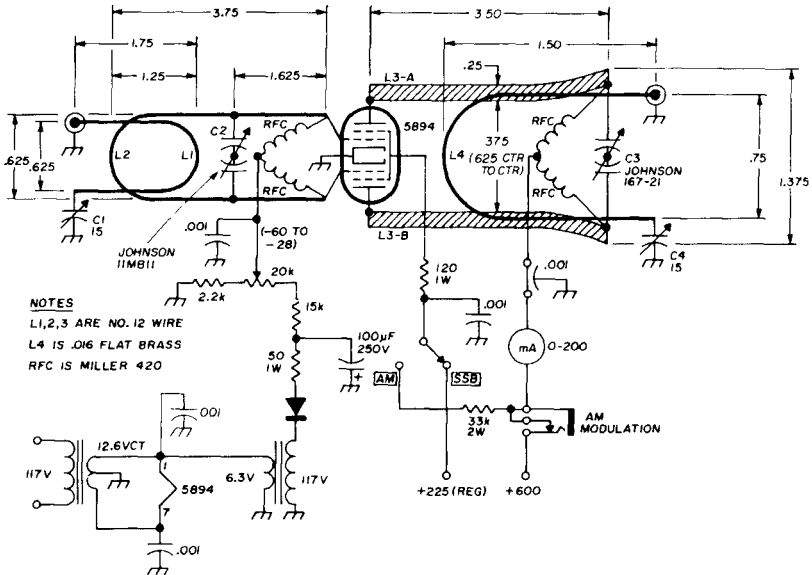

fig. 1. Complete circuit details for the 432-MHz rf power amplifier. Screen and filament by-passes may be built into socket. Idle plate current 40 mA normal; 100 mA peaks on ssb.

have built-in bypass capacitors. A conventional socket will work, however, if the leads to the socket bypasses are short.

tuning and adjustment

You won't have any difficulty tuning the amplifier if inductance dimensions are followed. Some kind of output-power indicator is required. If you don't have an in-line swr/power meter, an acceptable indicating device can be made as follows.

Sew about two inches of enamelled wire beneath the output coax cable shield. Terminate one end of the wire in a noninductive 50-ohm load on the end toward the antenna. Connect the other end of the wire to a 1N34 diode. Bypass the diode, and connect the other end of

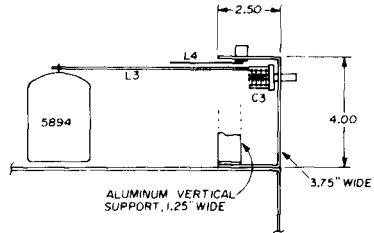

load, connect your antenna, apply full power, and you're in business.

After initial adjustment, little or no retuning will be necessary unless a fairly large change in operating frequency is made.

My 5894 amplifier has been operating for several months and has put a signal into the fringe areas over 100 miles away across several mountain ranges.

ham radio

improving overload response in the Collins 75A-4 receiver

Simple modifications
provide 13 dB higher
signal-handling
capability
in this
fine receiver

Having obtained only limited results trying to improve the performance of commercially designed electronic equipment, I came to the conclusion that the designers knew what they were doing all along. Even so, the temptation to modify equipment is hard to resist, and my latest modification attempt resulted in a 13-dB improvement in strong-signal-handling capability of the 75A-4 receiver. However, this was achieved by second-guessing Collins engineers some fifteen years after the set had been marketed!

A recent book on ssb techniques indicates that a substantial improvement in receiver overload response can be obtained by reworking the mixer circuits.¹ Those interested in the subject are urged to obtain a copy of this work.

I decided to modify my 75A-4 because several nearby stations caused front-end overload. This causes a decrease in weak-signal strength, even though the interfering signals are 25 to 50 kHz away. It's all but impossible to copy a weak cw signal under these conditions.

The remedy is easy: about five dollars worth of parts and a little time. Here's how to do it.

primary work

First replace marginal tubes, then align the receiver. Overload response may be checked using the setup in fig. 1. Set signal generator 1, representing the desired signal, to 3 microvolts at 14,050 MHz. Turn the receiver avc off and the bfo on. Now increase generator 2's level (at 14.025 MHz) until the desired signal, measured by the vtvm, decreases by 3 dB. This will require about 13,000 microvolts. All subsequent measurements are referenced to this level.

fig. 1. Test circuit for measuring effectiveness of receiver modifications.

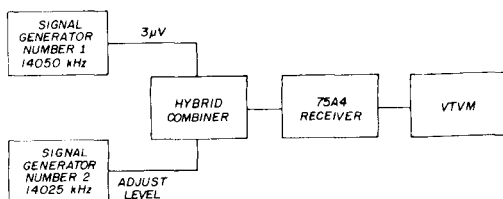

Raymond F. Rinaudo, W6ZO

first mixer modifications

Replace the 6BA7 first mixer with a 12AT7. The modifications, **fig. 2B**, require only one 470-ohm $\frac{1}{2}$ -watt resistor and the 12AT7. Remove R14, R15; C35, C36. Revise the heater circuit as shown.

Next replace the 100-pF coupling capacitor with a 15-pF silver mica, then connect another 15-pF silver mica between grid and ground. This forms a capacitive voltage divider that reduces signal level to the first mixer grid. (The photos show a modified and unmodified set; actually, these are photos of two different receivers.)

After these changes have been made, peak the mixer grid and crystal-oscillator circuits for each band; also peak the mixer plate circuit. Only the capacitors should be peaked: C23, C26, C28, C30, C31, C32 and C17 in the mixer grid and C53 in the plate circuit.

The high-frequency crystal oscillator tuned circuits must also be retuned. Peak the tuning slugs on L11 through L17. Until the oscillator has been peaked, you'll probably find that the 21-MHz and higher-band crystals won't oscillate.

After the first mixer has been modified, a 24,000 microvolt signal will be required to cause a 3-dB decrease in the desired signal. I made this test before the two 15-pF capacitors were installed.

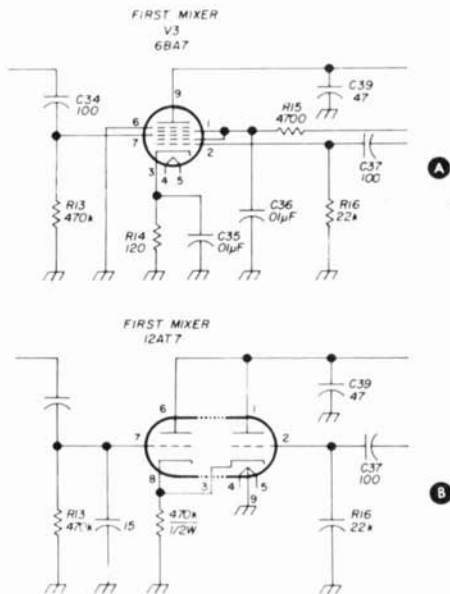
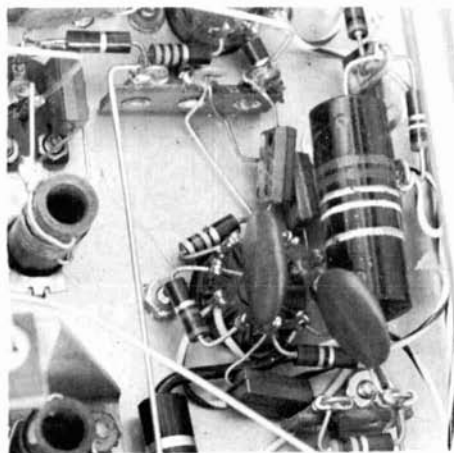

fig. 2. The 75A-4 first mixer before modification, A, and after, B. New parts consist of the 12AT7 and the 470K resistor.

second mixer modifications

The next step is to replace the 6BA7 with a 6DJ8. Before and after circuits are shown in **fig. 3**. The new tube plus four new parts are required: a 1k, 1.2k and 3.3k $\frac{1}{2}$ -watt resistor and an 820 pF silver mica capacitor. If you can't find an 820 pF capacitor, anything between 680 and

Wiring of unmodified 75A4 first mixer.



Modified first mixer; note reduced number of parts.

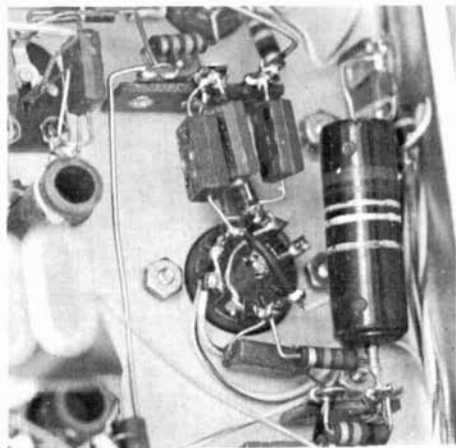

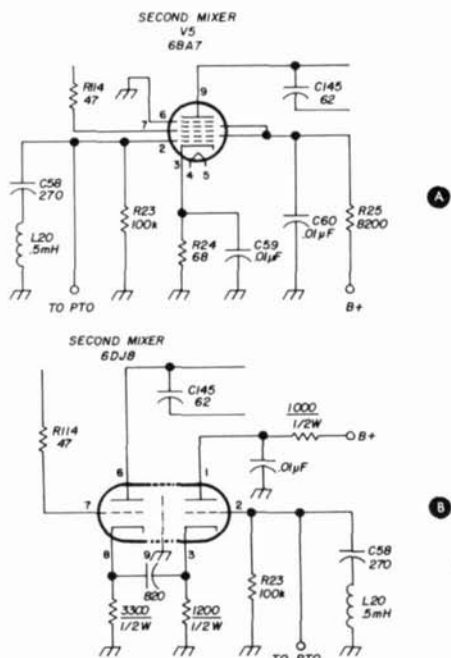
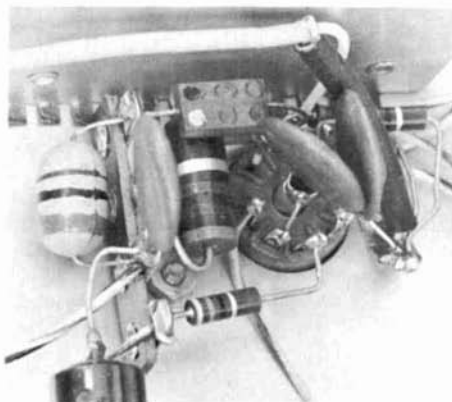

fig. 3. The 75A-4 second mixer. Original circuit is shown in A; modifications in B. Only five new parts are required for the change.

1000 pF will do. Remove R24, R25 and C59. Heater wiring is unchanged in this circuit. Complete the revision shown in fig. 3B. Peak the grid input circuits by tuning C56. Do not change inductor tuning.

After making the changes to the

Unmodified 75A4 second mixer.



second mixer, check receiver performance again. A 40,000 microvolt signal from generator 2 will be required to reduce the desired signal by 3 dB.

final checks

In my receiver, the capacitive voltage divider was installed after modifications to the second mixer. A final check showed that an undesired signal of 60,000 microvolts was required to reduce the desired signal by 3 dB (voltage ratio of 4.5).

conclusions

Measurements at 28 MHz showed an improvement of 3 dB in signal-plus-noise ratio. Over-all receiver gain was somewhat lower, but this was more than compensated by the receiver's response to weak signals in the presence of local signals. More than enough gain was still available, however.

A type 6922 tube can be used instead of the 6DJ8. The 6922 has the same characteristics as the 6DJ8 but costs about three dollars more.

The modifications described are easily applied to the Collins 75A-4 receiver. The improvement in performance is well worth the investment in time and money.

references

¹ Pappenfus, Breune, and Schoenike, "Single Sideband Principles and Circuits," McGraw-Hill, Inc., New York.

ham radio

Component layout of modified second mixer.

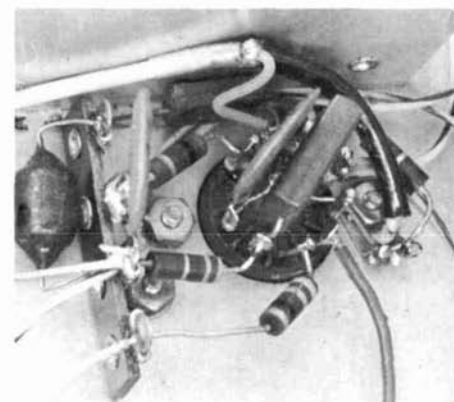



A HANDSOME PAIR
MATCHING
BOUND VOLUMES and BINDERS
FOR YOUR
HAM RADIO COLLECTION

Binders	\$3.95
1968 Bound Volume	\$14.95

All Prices Postpaid

HAM RADIO MAGAZINE
GREENVILLE, N. H. 03048

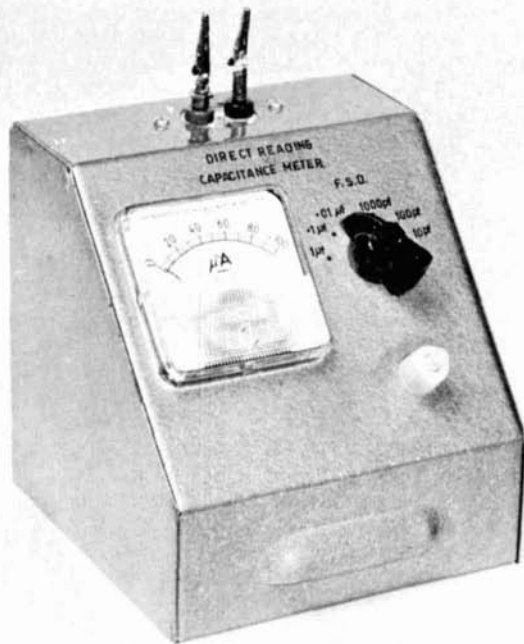

direct-reading capacitance meter

An easily built
instrument
with many uses
around your station

The instrument described here evolved from a bench lashup I used for measuring small values of capacitance. The original circuit used a cross-coupled multivibrator to provide the required square wave. I developed the present circuit to avoid complicated switching and to minimize the number of parts.

The meter has six ranges. The lowest is 0-10 pF; the highest is 0-1 μ F. The scale is linear, and if the timing capacitors are chosen carefully, the meter should have at least 5 percent accuracy. This is better than the tolerance on many capacitors between 1-100 pF.

features

I've found this instrument to be invaluable for measuring:

Mark King, ZL2AUE

1. Tuning capacitance—maximum and minimum values
2. Coax cable capacitance
3. Feed-through capacitance values (important at vhf)
4. Circuit strays
5. Capacitors with obliterated markings
6. Junction diode reverse capacitance

The instrument is also useful as a square-wave source for test purposes.

operating principles

If a square wave is applied to a capacitor and resistor in series, and if their time constant is much shorter than

integrator. The meter also provides the resistance for the differentiator. This being the case, a 0-100 microammeter was chosen, because its high resistance (in this case 10k) made for easy differentiation of small capacitances at a relatively low square-wave frequency. This should be born in mind if you wish to use a meter with a lower sensitivity.

On the other hand, the largest capacitance that can be measured with a low square-wave frequency is limited by needle jitter. The meter's integrating effect decreases as you approach dc.

design

Initial mockups of the circuit used a unijunction transistor to generate a sawtooth wave that was applied to a limiting

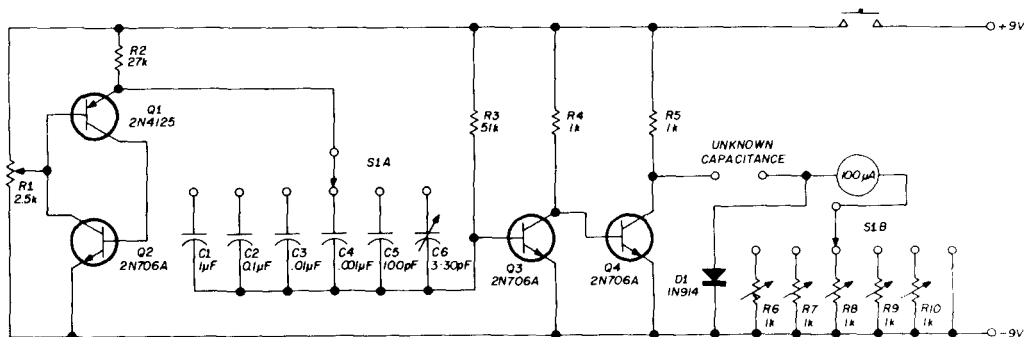

fig. 1. Capacitance meter schematic. R1 adjusts output of square-wave generator Q1, Q2. Trim pots R6-R10 adjust timing capacitors C1-C6 during calibration, then remain fixed. Instrument should provide at least 5 percent accuracy.

the square wave's period, the combination acts as a differentiator, which produces a sharp voltage spike. If these spikes are integrated, a voltage will be developed that has a linear relationship to the square wave's period if the period is varied over a small range.

If, instead of varying the square wave's period, the differentiating capacitor's value is varied over a limited range, a similar effect occurs wherein the integrated voltage bears a linear relationship to the differentiating capacitance.

practical considerations

In practice the unknown capacitor provides the differentiating capacitance, and the meter movement acts as an

amplifier. The problem with this scheme was that, at the higher frequencies, insufficient output was available from the transistor at hand to drive the limiting amplifier.

In practice it proved less expensive to use the transistor pair in fig. 1, and it was also easier to adjust this combination for optimum waveform. It was pure coincidence that the timing capacitors corresponded to the maximum capacitances of the various ranges. The pre-set pots in series with the meter on each range are for very fine adjustment only. Too much resistance here will disturb the linearity of each range. If the calibration can't be brought within range with the pots, then the timing capacitors must be altered.

construction

All components except the range switch, pushbutton switch, and meter are mounted on a PC board. The printed circuit was masked-in with a marking pen applied directly onto the laminate board. Unwanted copper was etched away with a concentrated solution of ferric chloride. The board was floated on the solution. Etching took about an hour at room temperature.

When completely etched, the board was thoroughly washed and dried. Remaining marking-pen ink was washed off with isopropyl alcohol; methyl alcohol will work as well.

The battery terminals were salvaged from an old type 216 transistor-radio battery. They were mounted directly on the circuit board with the other components. The measurement terminals were made by soldering small alligator clips to banana plugs. Sockets were mounted through a piece of lucite. They are spaced $\frac{1}{2}$ -inch apart. A hole was cut in the top of the instrument enclosure to clear the terminals by $\frac{1}{4}$ inch.

calibration

Calibration accuracy is determined by the tolerance of the timing capacitors. If

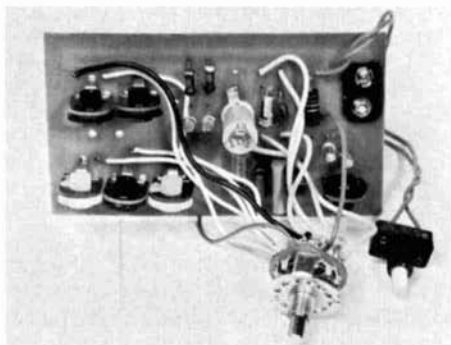

Parts layout. Chassis is an easily made etched PC board, described in the text.

possible, choose values in the middle of each range, and adjust for correct readings with the trim pots.

If calibration can't be obtained with the trim pots, then the timing capacitors will have to be adjusted. As a further check, use a capacitor that gives a full reading on one range. Then the meter should read only 10 percent of the next-higher capacitance range.

operation

When measuring a capacitor, set the range selector to the highest range for a start. If the capacitor under test is larger than the range maximum, the capacitor will act as a low-impedance coupling between the drive transistor and the metering circuit, thus overdriving the meter.

The maximum current through the meter on the lowest capacitance range, when a large-value capacitor is connected, is 3 mA. If the terminals of the instrument are short-circuited, the current will be only 60 microamps. This is because Q4's collector will be effectively grounded through the metering diode. If the meter tends to read in a reverse direction, this indicates a leaky capacitor being tested.

The instrument is powered by a 9-volt transistor battery. Current drain is about 20 mA, but battery life should be good since a pushbutton switch connects the battery only when required.

ham radio



"Ten bucks for the crystals --
and 50 cents for the rig."

WHAT'S BLACK AND GREY, WEIGHS TWO POUNDS AND TALKS IN AN ELEVATOR SHAFT?

An HT-2!

Varitronics' new 2 meter FM walkie-talkie • Works anywhere • Super hot receiver • 1.6 or more watts out • Ni-cads and charger supplied • Only \$269.95.

See it at your dealer

VARITRONICS INCORPORATED

3835 North 32nd Street • Suite 6 • Phoenix, Arizona 85018

See us at the Dayton Hamvention in April

partners in excellence



An outstanding technical guide to all phases of amateur radio. In 832 pages 20 complete chapters are devoted to such subjects as single sideband, antennas, mobile equipment, RTTY and much, much more.

This excellent book has received wide acclaim on both sides of the Atlantic and belongs in your library . . . now. **\$11.95**

OTHER

POPULAR RSGB PUBLICATIONS

Radio Date Reference Book	\$2.50
VHF-UHF Manual	3.75
Amateur Radio Techniques	2.50
Amateur Radio Circuits Book	2.00
World at Their Fingertips	2.50

All prices postpaid in USA & Canada

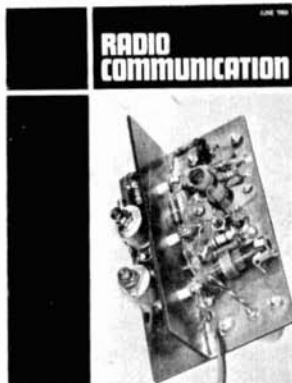

Many thousands of you have become very familiar with the various Radio Society of Great Britain books and handbooks, but very few of you are familiar with their excellent magazine, **Radio Communication**.

This is the oldest and most widely read British amateur radio magazine. Published monthly it provides complete coverage including such popular features as: Technical Topics, a monthly survey of the latest ideas and circuits, Four Meters and Down, a rundown of the latest in VHF and UHF and much more.

It includes numerous technical and construction articles in addition to a complete rundown on the month's events in amateur radio. Surely a most interesting addition to your amateur radio activities.

We can now offer this fine magazine to you along with the other advantages of membership in the RSGB (such as use of their outgoing QSL Bureau) for only \$6.00 a year.

book division

comtec

Box 592 • Amherst, New Hampshire 03031

"WE ARE THE EXCLUSIVE NORTH AMERICAN DISTRIBUTOR FOR RSGB PUBLICATIONS — DEALER INQUIRIES INVITED"

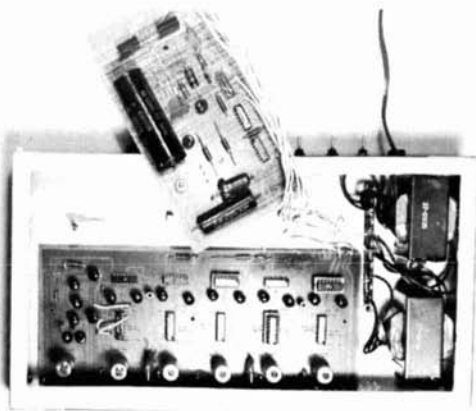

24-hour digital electronic clock

interesting in building an all-electronic digital 24-hour clock? With some of the new inexpensive digital integrated circuits that are on the market you can put one together for less than \$230 if you buy all new parts. When Motorola Semiconductor announced their MC780P decade counter and MC9760 decoder a few months ago, it was like putting a good nickel cigar on the market. This clock is designed around these ICs, as is the optional built-in ten-minute timer shown in **fig 2**. Further cost savings resulted by using Burroughs B-5750 Nixie tubes—just about the most inexpensive readouts available.

Although a 24-hour clock is easier to build than a 12-hour version, all of the ingredients for a 12-hour version are included in the 24-hour clock with the exception of a couple of low-cost gates.

In the 24-hour clock, **fig 1**, the "seconds" and "minutes" section count to 60, and then reset to zero. At the end of each hour a pulse is transmitted to the decade counter in the "hours" section. This continues until 23 hours, 59 minutes, and 59 seconds (23:59:59). The next pulse from the clock generator in

the power supply resets the "seconds" and "minutes" counters to zero, and advances the "hours" section to 24. The number "24" is recognized by the decoder made up of gates G1 and G2, triggering the Schmitt-trigger circuit that resets the "hours" section to zero.

clock pulse generator

The power supply and clock pulse generator are shown in **fig 3**. The one-second pulses are derived from the ac power line. The 60-Hz line signal is applied to integrated circuit U1 which is connected as a Schmitt-trigger: the output is a fast-rising pulse that is used to trigger the divide-by-six counter, U2; integrated circuit U2 drives a divide-by-ten stage, U3. Switches S1, S2 and S3 are used to select a divided output so the clock can be quickly set manually. Capacitor C1 suppresses spikes on the line and keeps rf energy from falsely triggering the solid-state circuitry. The output of the divide-by-ten counter is buffered by one half of U1.

A regulated supply of 3.9 volts is required for the ICs; the 170-volt output

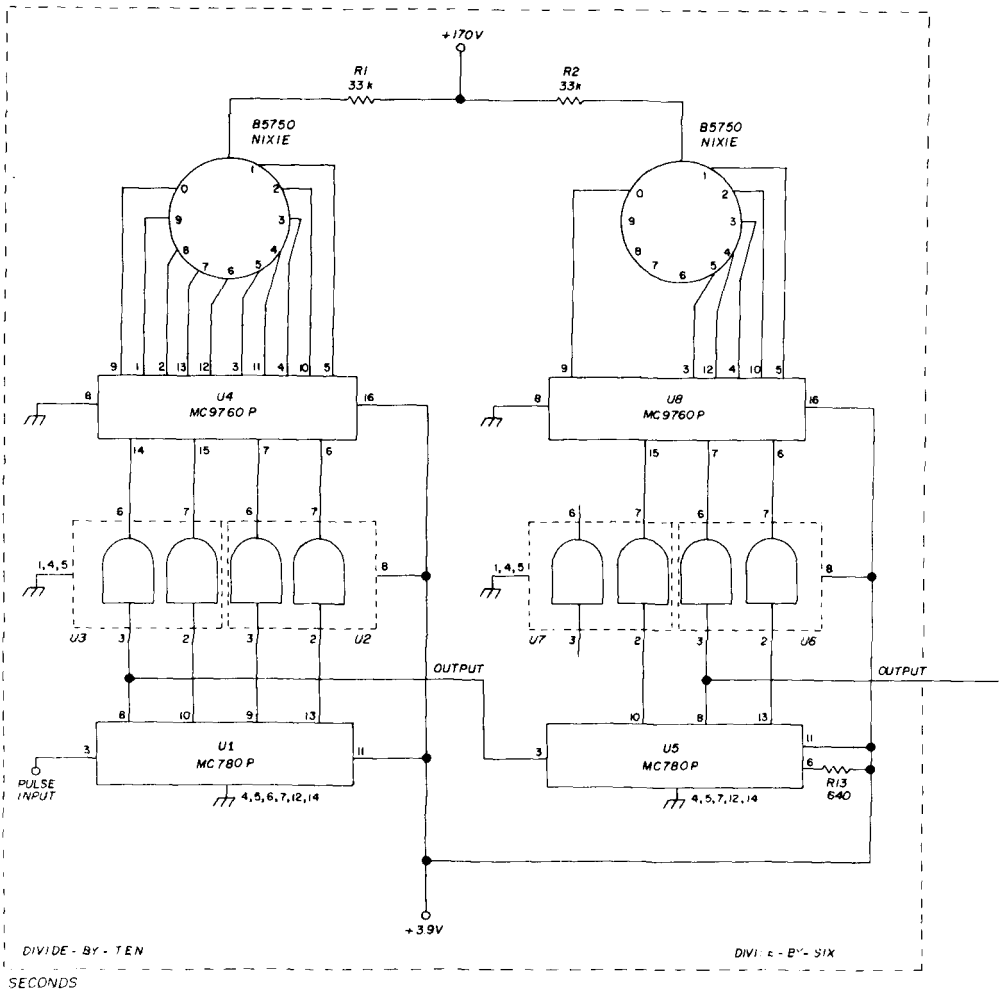

fig. 1. Complete circuit diagram of the all-electronics digital 24-hour clock.

is for the readout tubes. This should be checked closely after the power supply is put together because resistors R1, R2, R5, R9, R10 and R18 were designed for 170-volt operation. The MC9760P will handle 70 volts, but it's best to start with the voltage on the low side (with dimmer readouts) than to zap the expensive integrated circuits.

construction

Etched circuit boards are used throughout the clock shown in the photographs.* The completed circuit boards are mounted in a 13x7x2-inch aluminum chassis. On one side a rectangular cutout, 1½ by 8¼ inches, allows the readout tubes to

be seen. A thin sheet of tinted plastic covers the front of the clock. The switches for setting it are mounted on the rear deck next to the ac line cord.

The colons between hours, minutes and seconds are formed by miniature neon lamps, their bodies painted except for the tips. The wire leads to the lamps are left about two inches long, and formed to hold the lamp in the correct position.

*circuit boards for this clock are available from Stafford Electronics, Inc., 427 So. Benbow Road, Greensboro, North Carolina 27401. Clock board, DCU-700, \$12.50; power supply board, DCU-720 \$2.75; 10-minute timer board, DCU-721, \$3.00. A complete kit of electronic parts for a 24 hour clock (less 10-minute timer) is \$230.00.

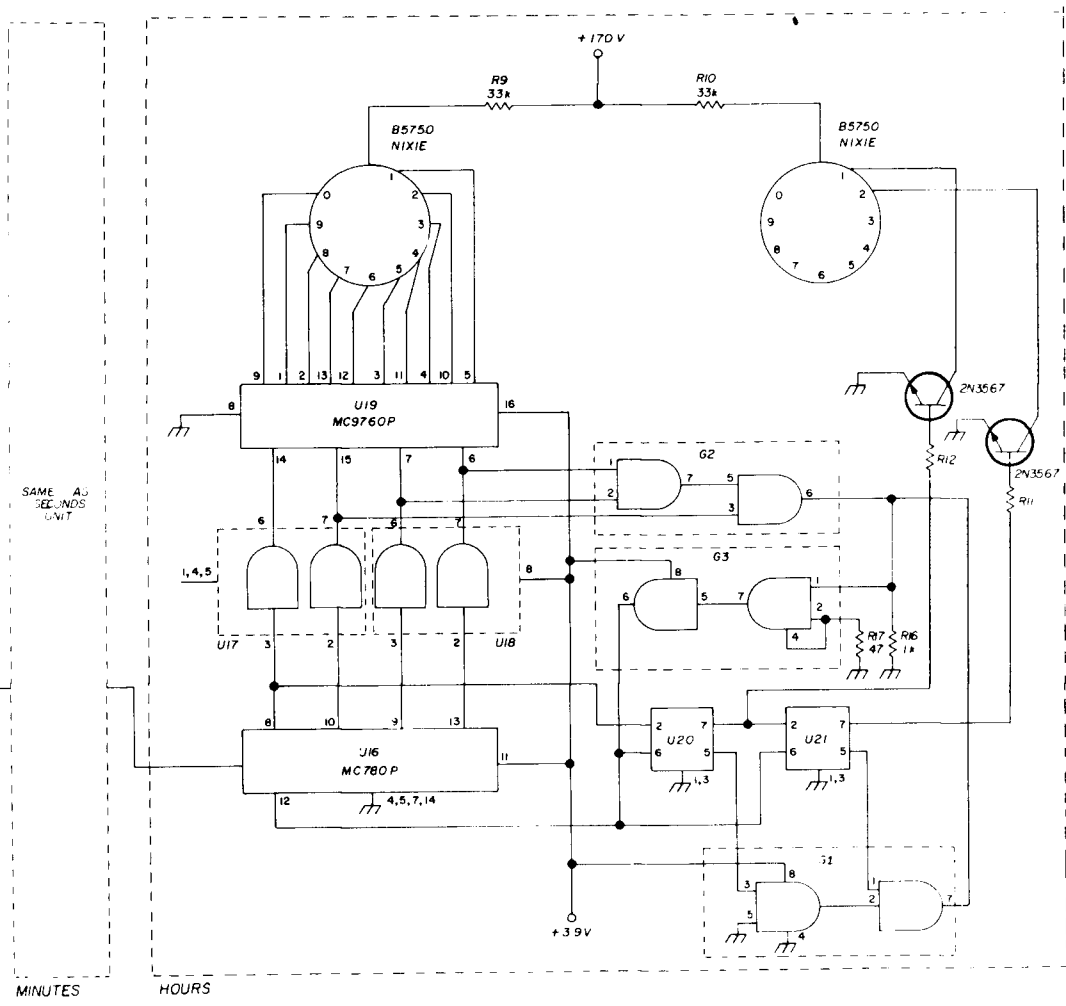

circuit variations

If you want 12-hour operation instead of 24, make the following circuit changes:

1. Remove R11, Q2 and U20.
2. Cut leads 2 and 7 on G1 and put a strap between these two points.
3. Remove the strap from pin 12 of

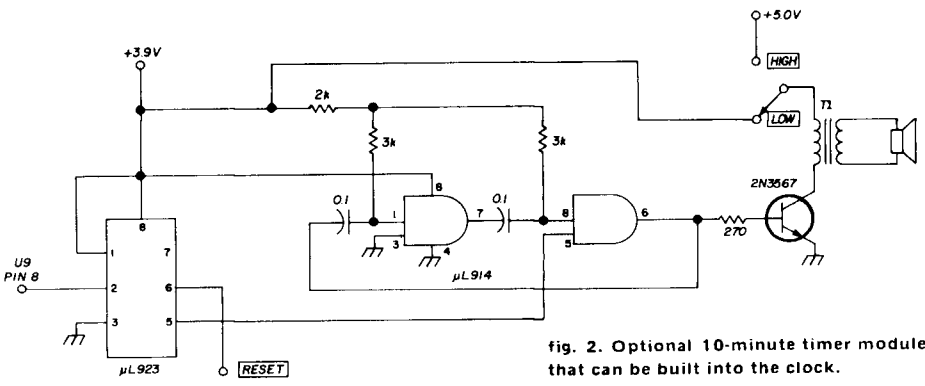

fig. 2. Optional 10-minute timer module that can be built into the clock.

GET IN ON THE ACTION

HAM RADIO continues to grow at a pace we find hard to believe ourselves. Last year we doubled in size. It looks like we will do it again in 1970.

Don't take the chance of missing a single issue of this exciting magazine. Remember a three year subscription costs less than 1/2 the newsstand price.

HAM RADIO MAGAZINE — Greenville, NH 03031

HELP ME SAVE MONEY

Enclosed is \$12.00 for 3 years \$6.00 for 1 year

Name

Address

City State Zip

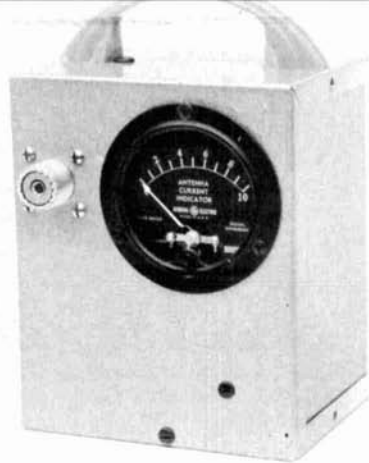

low-power dummy load and rf wattmeter

An accurate
and reliable
test instrument
that can be built
for less than
five dollars

The advantage of using a dummy load for rf tests are many. No interference is created, and station identification isn't required for prolonged test periods. If the dummy load contains a calibrated meter, you can measure rf power with good accuracy.

Most hams have dummy loads that will handle a kilowatt. While these are fine for their intended purpose, most won't provide accurate readings at power levels of 25 watts or less.

The unit described in this article is a highly accurate dummy load and rf wattmeter that can be used for testing low-power transmitters. Two versions are described: one is limited to 11 watts, and the other is good for 25 watts. Essential components cost less than two dollars. The enclosure, connector, and handle bring the total cost to less than four dollars. Sound interesting?

11-watt load

My original load used eleven 2-watt resistors in parallel. To save a buck, I used ten composition resistors, each 560 ohms, and one 680-ohm resistor. These are rated at 2 watts, 10 percent tolerance. I chose them because they're widely available and cost less in quantities of ten units.

The resistance of this dummy load is 51.73 ohms, which provides a good match for popular coaxial cables. Power capacity is limited to 11 watts. This is because composition resistors should not be used at more than 50 percent of their power rating, otherwise their resistance will change, which will degrade the accuracy of the wattmeter.

I mention this for those who might wish to build a very low-power unit with readily available resistors. The schematic of fig. 1 can be used, substituting the

Neil Johnson, W2OLU, 74 Pine Tree Road, Tappan, New York 10983

composition resistor bank for R (see photo).

25-watt load

Better resistors will allow rf power measurements up to 25 watts. The better units turned out to be another of those surplus bargains that appear from time-to-time.* I ordered two of these and connected them in parallel to obtain 50 ohms.

In an earlier project I used the 25-watt version of these resistors in a dummy load.¹ Four resistors, each 50 ohms, were connected in series-parallel. The CGW resistors can be extremely overloaded and will retain their accuracy to a remarkable degree. The 25-watt units used in the load described in reference 1 have been sold

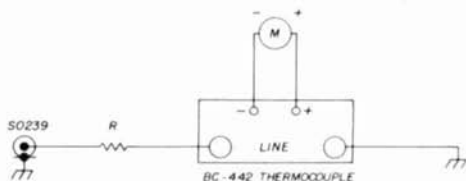

fig. 1. Schematic of the 25-watt dummy load and rf wattmeter. Resistor is two 100-ohm resistors in parallel; each resistor 13 watts, 1% non-inductive type.

out. However, for those who may have some, the data provided in table 1 should be helpful. I believe the overload characteristics with respect to permanent resistance change also apply to the 13-watt units.

thermocouple and meter

These components are another "ham special" value.† Both units came from the BC-442 antenna tuning unit. They are first-rate, rugged, accurate components originally designed for military use. The dc meter has a nonlinear scale, a relatively expensive type of meter construction not

*John Meshna, Jr., 19 Allerton Street, Lynn, Massachusetts 01904. Catalog listing: "Corning Glass Works, Tin-Oxide Film Resistors; 100 ohms, 13 watts, 1% tolerance." Price: 35 cents each.

†Fair Radio Sales, P. O. Box 1105, Lima, Ohio 45802; \$1.25 for both thermocouple and meter.

table 1. Data for the CGW 25-watt resistor.

tolerance	2.5 or 10%
stability	less than 1% permanent resistance change*
operating temp	25°C
manufacturer	Corning Glass Works, Raleigh, N. C.
marking	CGW R35 25W 50 ohms

*When operated at 10 times rated power for 5 seconds.

generally associated with amateur equipment. This gives an expanded scale at the low end, and rf output as low as 2 watts can be measured.

My experience with this meter and thermocouple has shown them to be highly accurate and dependable. This comes as no surprise when it's realized that these units had to withstand constant vibration in flight, hour after hour, plus the many shocks in taking off and landing at some rugged air strips.

construction

Construction details are shown in the photos. The usual procedure of keeping rf leads short and direct should be followed in wiring this simple instrument. This will ensure a vswr of 1.1 or better throughout most of the amateur high-frequency bands.

Inside the wattmeter, showing the CGW "R Series" resistors.



table 2. Calibration data.

meter reading	true rf amperes	rf watts into 51 ohms
1	—	0.9
2	—	1.8
3	0.23	2.7
4	0.28	4.0
5	0.335	5.6
6	0.39	7.9
7	0.46	11.0
8	0.54	15.2
9	0.64	21.4
10	0.78	31.4

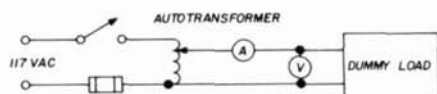

fig. 3. Circuit used for calibration. A is a Weston model 433 ac ammeter; V is a Simpson model 261 ac voltmeter (see text).

calibration

The calibration data shown in table 2 and fig. 2 were obtained with the setup shown in fig. 3. The wattmeter was calibrated at 60 Hz, using mirror-scale laboratory instruments: a Weston Model 433 ac ammeter and a Simpson Model 261 voltmeter.

The voltmeter takes power, so I checked it against the Weston 433 before starting the calibration procedure. Readings were checked going up and down the scale. Then a second check was made to ensure repeatability of the data.

Note that the meter reading at 10 (table 2) occurs when the resistors are operated beyond their maximum power

Composition resistor bank used in the 11-watt unit.

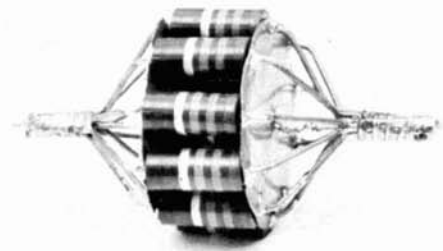

rating. No harm is done to either meter or resistors. A temporary effect was that the resistors changed value to 50.5 ohms, and the entire dummy-load resistance increased to 51.5 ohms. The resistors returned to their original value upon removal of rf power.

The 51-ohm resistance of the unit is due to the series combination of the resistors (50 ohms) and the thermocouple, approximately 1 ohm. Note that readings below 0.23 ampere are not valid.

If you intend to use the instrument at levels above 15 watts for extended periods, some means of auxiliary cooling should be used. Removing the cover will also help.

conclusion

The amount of abuse the CGW resistors will take staggers the imagination.

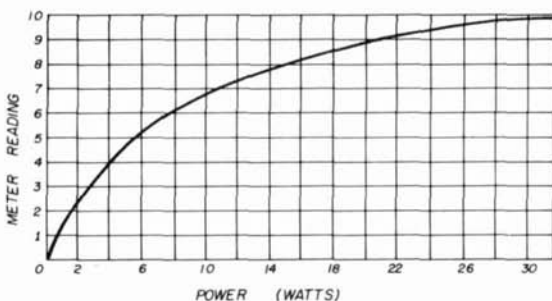

fig. 2. Calibration curve for the low-power wattmeter.

For example, my old 200-watt load¹ withstood a kilowatt for 5 seconds maximum without resistor values changing more than 1 percent (permanent change after cooling). By the same token, the smaller resistors, which have a nominal rating of 26 watts per pair, could be run up to 260 watts.

A high-quality rf wattmeter, good for any power up to 25 watts, is not a bad investment for \$4 and a pleasant hour's work.

reference

¹Neil Johnson, W2OLU, "A 200-Watt Dummy Load for \$2.00", 73 May, 1967, p. 66.

ham radio

vhf-uhf manual

BY G.R.JESSOP, C.Eng., MIERE, G6JP

published by the Radio Society of Great Britain

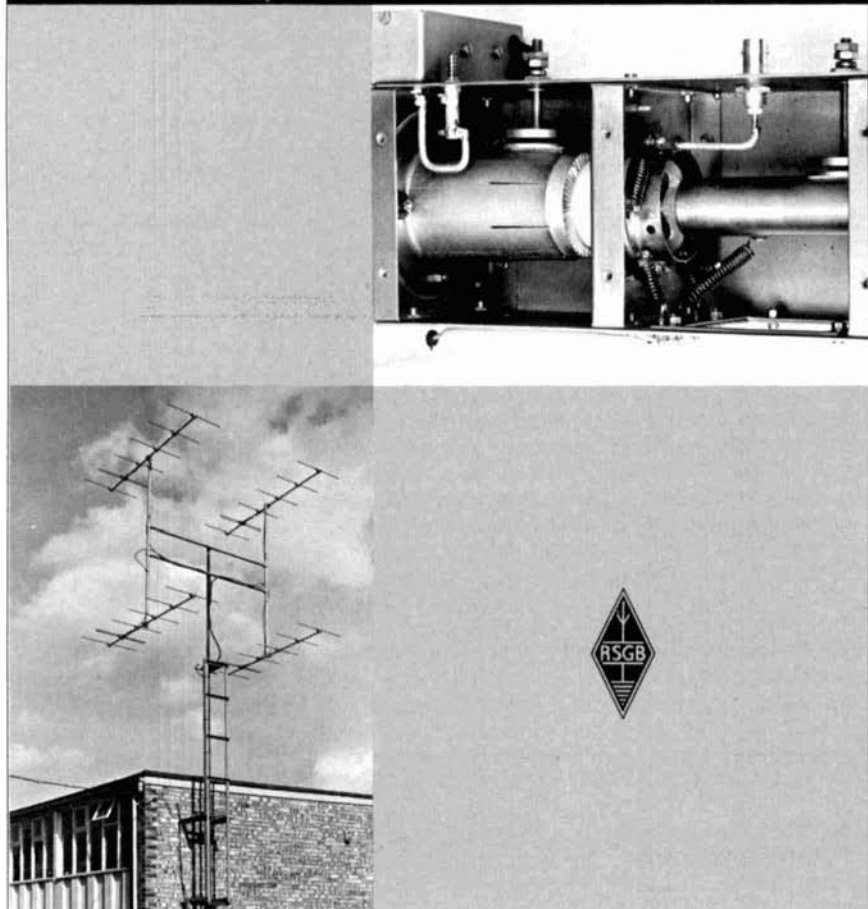

If you have any interest in the frequencies above 30 MHz then you need this book. It is probably the most comprehensive work of its kind ever produced, ranging from advanced material to simple circuits for the beginner to vhf. An attractive layout and clear style make the VHF/UHF Manual a most worthwhile addition to your library.

3.75 postpaid

book division

comtec

Box 592 • Amherst, New Hampshire 03031

**"WE ARE THE EXCLUSIVE NORTH AMERICAN DISTRIBUTOR FOR RSGB PUBLICATIONS —
DEALER INQUIRIES INVITED"**

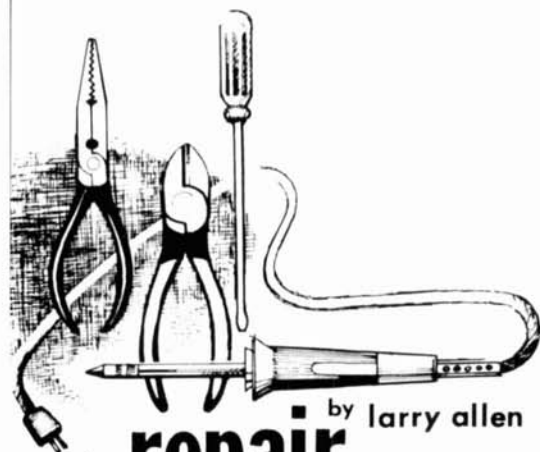

by Larry Allen

the repair bench

how to use a sweep generator

Television repair technicians — the good ones — learn to use a sweep generator early in their careers. It's a must. There's no other way to align a TV set, because its i-f stages are stagger-tuned. That is, they're aligned to various frequencies. It takes a sweep generator to show how they're tuned and the effect they have on the wideband television signal.

But I've discovered an awful lot of hams don't understand a sweep generator. If you don't, read on. I'm going to explain it.

You can use a sweep generator to help you design interstage coupling transformers and wind them with just the bandwidth you want. Or, if you tinker with ham TV, you'll need it to keep your receiver aligned. It's also a good troubleshooting tool when your ssb receiver (or any receiver, for that matter) has rf or i-f trouble. You can even watch the effects of agc (or avc) on bandwidth.

the instrument

Sweep generators for general use are scarce these days. Many new models are for television sweep alignment, and put only TV i-f and channel frequencies. But some general-coverage models are still available. Here's a list of those I've seen and used:

- EICO 369
- Heathkit IG-52
- Knight-kit KG-687

The Knight-kit has a built-in marker generator; I'll explain its purpose, too, later.

You can see what they look like in **fig. 1**. These cover frequencies from about 3MHz to 220 MHz, the high end of the vhf TV band. You can often use harmonics of the dial frequencies up to nearly 900 MHz, with reduced output of course. Stability is usually critical at that high a harmonic. But the fundamentals, as you can see, encompass most ham frequencies.

What, exactly, is a sweep generator?



fig. 1. Two sweep generators that are suitable for the amateur workbench.

fig. 2. Hookup for measuring response by hand and graphs of parallel-tuned circuit (B) and series-tuned trap (C).

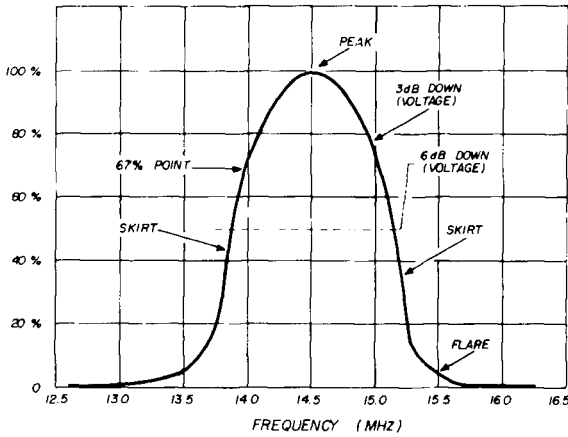
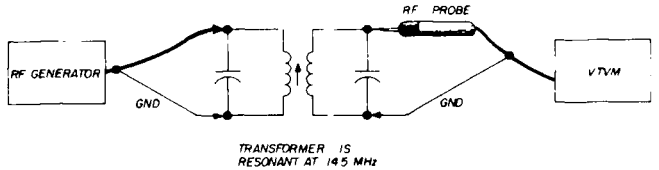

down 60 times every second.

Suppose, for example, you set the dial for 14.5 MHz. The sweep circuit swings the oscillator above that and below it. If the generator is set to sweep 5 MHz, the oscillator is swung downward to 12 MHz, then up through 14.5 MHz to 17 MHz. It thus goes from center to one end, to the other end, and back to center, 60 times per second. The 5 MHz is called the *sweep width* and the 14.5 MHz is called the *center frequency*. The 60 Hz is called the *sweep rate*; that's the same on all service-type sweep generators.

response curve

Now for some principles of what the instrument is for. Let me review tuned circuits. They are the only reason you ever need a sweep generator.

The most important characteristic of an LC circuit is the frequency it's resonant to. Second most important is how well it rejects nearby frequencies—in other words, how sharp its resonance is. Together, these are the *response* of a tuned circuit.

You can plot the response of any tuned coil-capacitor combination. You just feed in a lot of different rf signals, one at a time, and graph how the circuit responds to each one. The hookup is shown in **fig. 2A**, and the graph of results with one tuned circuit is **fig. 2B**.

Here's how it's done. Tune the generator to whatever frequency makes the highest reading on the vtvm. Mark that on the center of the graph at the 100% line, and write the frequency directly below it along the bottom of the graph. This one happens to be peaked at 14.5 MHz.

Then start slowly downward with the tuning dial of the generator. Above the 14.25-MHz line, make a dot that represents the voltage that gets through the

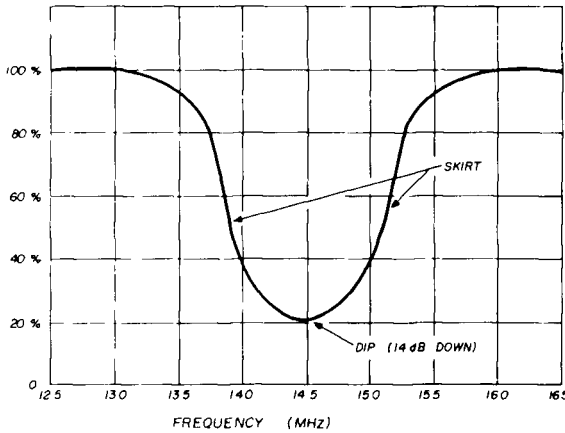

You'll understand better as I show you what it does, but here's a brief description.

An oscillator creates an rf signal at whatever frequency is set on the generator's dial. A sweep circuit in the generator is connected so it tunes the frequency of the main oscillator up and down, as if you were turning the dial above and below the frequency you first set it at. However, this sweep circuit is driven by a 60-Hz signal from the power line, and it swings the oscillator frequency up and

transformer. Show it as a percentage of what the voltage is at peak. As you tune the generator on downward, make voltage-level dots at every 0.25-MHz increment: at 14.0, 13.75, 13.5, 13.25, 13.0, 12.75, and 12.5 MHz.

broadband. The 6-dB points (half-way down) on its curve are at about 13.8 and 15.2 MHz. Its 6-dB bandwidth is approximately 1.4 MHz. At and below 13 MHz, response is nil; and it's nil at 16 MHz and above.

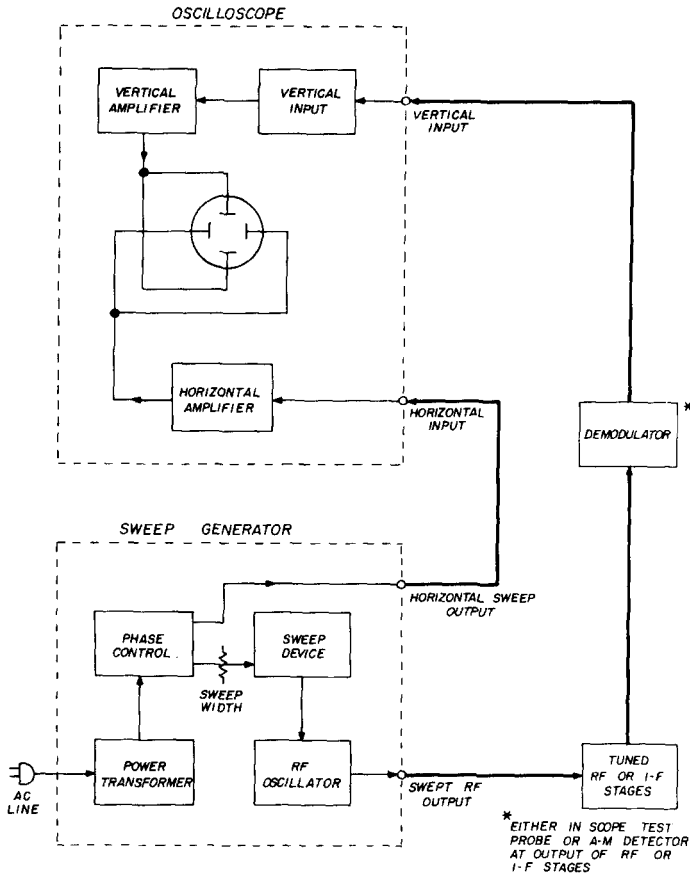

fig. 3. Connections for displaying response curve on a scope.

Then start again at the peak and move the generator dial upward. Mark the voltages at 14.75, 15.0, 15.25, 15.5, 15.75, 16.0, 16.25, and 16.5 MHz.

These dots represent how well the tuned transformer responds to each frequency. Joining the dots together with a solid line helps you interpolate responses at frequencies in between the increments you measured. The solid line forms a curve, which is a *response curve* for that particular tuned transformer.

This particular transformer is fairly

If you plot the response of a tuned circuit that's connected as a trap, the curve is inverted, as in fig. 2C. You plot this one starting at some frequency well below the expected response of the tuned circuit. The meter registers the full signal from the rf generator. As you turn the dial toward resonance, the rf voltage reaching the meter starts dwindling — at 13 MHz. It gets less and less. Once you tune past the resonant frequency, voltage of rf reaching the meter rises again. Eventually, you tune the rf generator

beyond the influence of the tuned circuit. That's beyond 16 MHz.

plotting automatically

What if you could turn the generator dial back and forth very rapidly and just as rapidly plot *all* the voltage points instead of just some? You'd develop the response curve a lot quicker. Well, you can. In fact, the whole thing can be done automatically.

You use an oscilloscope as the voltage-measuring device. And you use a sweep generator to swing the frequency up and down rapidly — 60 times per second. If the scope is synchronized to move its beam back and forth 60 times each second, the voltages measured at all frequency points by its vertical amplifier are displayed side by side. The outcome is a continuous curve of voltages right on the screen of the scope.

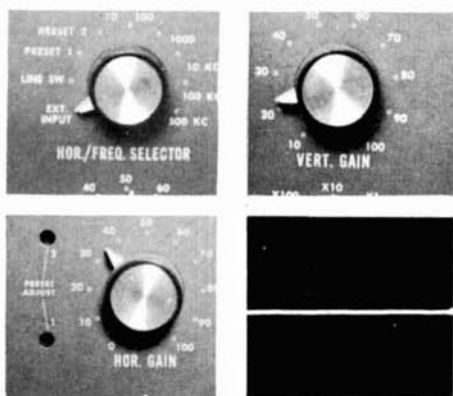

fig. 4. Settings of scope controls to produce response curve. Photo at bottom right shows a baseline before the demodulated signal is applied.

The sketch in fig. 3 lets you see in detail how to make the connections. The same 60-Hz voltage that operates the sweep circuit in the generator is fed by a connecting cable to the horizontal input of the scope. Applied to the horizontal deflection plates of the scope crt, it swings the beam back and forth exactly in rhythm with the sweeping of the rf oscillator in the sweep generator.

At the same time, the swept rf signal is fed to the tuned stages of circuits whose response you want to view. A demodulator probe (or a detector with the stages) develops an output voltage for each and every frequency in the band being swept, one right after another.

Those voltages go to the vertical plates of the crt. They move the beam upward in proportion to each voltage. Since the beam is at the same time being swept from side to side, each voltage level appears one after the other. And, since it is being swept exactly in step with the sweep-generator rf signal, the voltage levels occur in the same sequence as the frequencies.

This is done over and over, 60 times a second. Your eye sees an automatically plotted curve of the response. It's the response of the whole group of tuned circuits or stages to the band of frequencies being swept by the generator.

sweeping a receiver i-f

As I said, there are dozens of ways you can use this ability to see the response of a tuned circuit or stage. So I'll show you how to set it up. The i-f of a ham receiver makes a good example, but this hookup can work for any tuned circuit or any group of tuned stages. Just feed swept rf into the input and feed the output to your scope.

First connect up the sweep generator and scope as diagramed in fig. 3. Horizontal output of generator to horizontal input of scope. Rf output of generator to input of tuned stages (in this example, to the input grid or base of the i-f section). Using direct probe, connect scope vertical input to output of a-m detector. (If there's no detector, use the scope's demodulator probe.)

The photos in fig. 4 show settings of the important scope controls. Horizontal Sweep to "Ext." Vertical Input attenuator to X1 (the object is to set up the scope so a 2-volt peak-to-peak input signal makes a 2-inch vertical display). Horizontal Gain up just enough to make a base line about 3 inches wide. Positioning

controls to keep base line below center of screen. (If the diode in your demodulator probe or the a-m detector is connected with its anode on the output side, position the trace above center, because the response curve will come out negative — below the base line.) The last photo of **fig. 4** shows the scope crt screen, with the base line properly set up.

You set up the generator as pictured in **fig. 5**. Rf dial at frequency near center of bandpass you expect in tuned stages. Sweep Width about twice as wide as you expect. (The i-f in this receiver has a center of 5 MHz, and a normal bandwidth of 50 kHz. A very low sweep width setting is called for — about 100 or 150 kHz. A television video i-f requires a sweep width setting of 10 or 12 MHz.) Phase control must be set after response curve is visible on scope crt. Output control set just high enough to produce 2-inch display on scope (exact setting depends on amplification in tuned stages being tested).

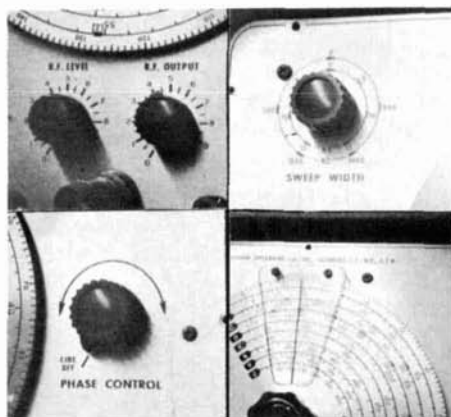
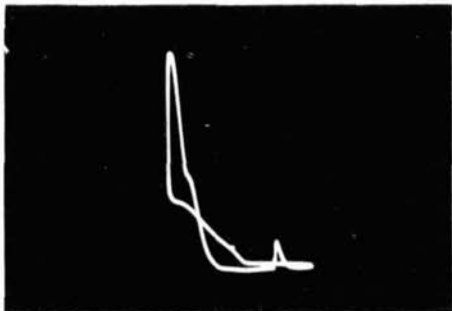

fig. 5. Control settings for the sweep generator.

Fig. 6 is what response curves look like. The top left photo shows it before you adjust the Phase control on the sweep generator. The top right one is a normal response curve of an operating i-f section in a ham receiver. The curve of any tuned circuit, or any group of circuits tuned to the same frequency, should look

fig. 6. Response curves.



Phase control needs adjusting.

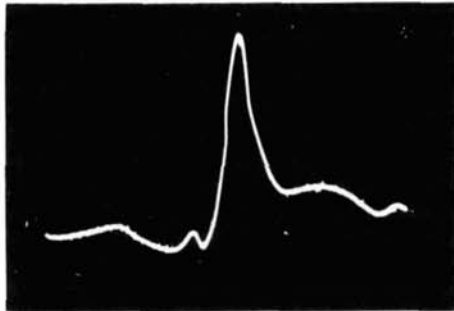

Normal narrowband curve.

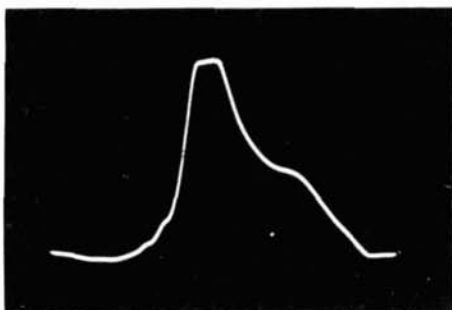

Bandwidth spread out by misadjusted slug.

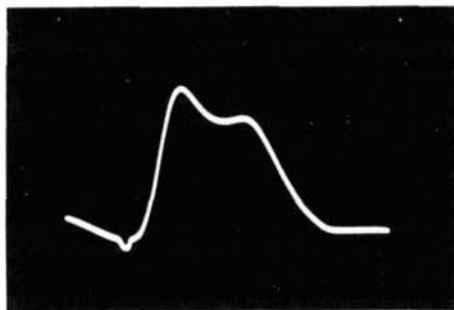

Wideband response of video i-f strip.

like this.

The bottom left photo is the response curve of the same i-f stages, but with two of the transformer adjustments mis-adjusted. As you can see, you can actually broaden out the response of the i-f, if that's what you want. For best QRM rejection, of course, you want the curve steep, narrow, and tall. That means, respectively, good adjacent-carrier rejection, good selectivity, and good amplification.

Incidentally, you might have to "clamp" the agc or avc line. Some receivers can't show a true response curve

side. The result is the wideband response curve you see.

There are trap circuits in a TV i-f, too. They are at 39.75, 41.25, and 47.25 MHz. Their major purpose is to eliminate any signals at those three frequencies; they interfere with the wanted signals. On the response curve, they are responsible for how steep the skirts are. Right beside the amplifying response curves, the trap curves drop the response faster at the edges than ordinary tuned circuits could.

marking the frequency

One deficiency of a response curve

fig. 7. Marker adder, shown external. Most modern sweep or marker generators have it inside.

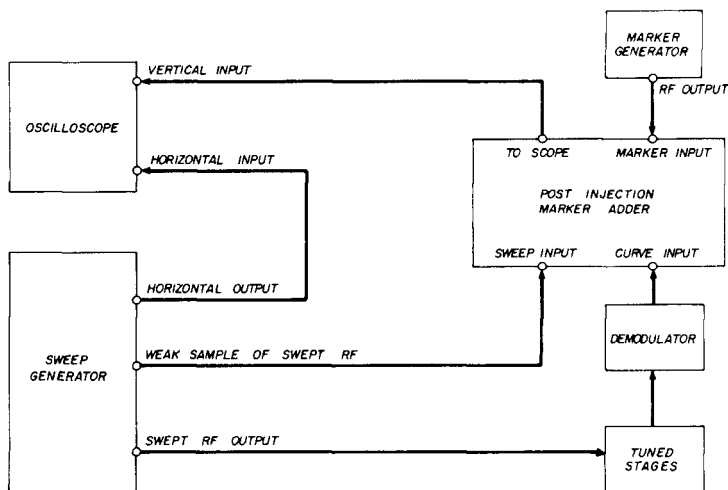

with the agc working. The alignment instructions will tell how much dc voltage to apply to the agc line if such a step is necessary.

wideband tuning

The bottom right photo in fig. 6 is the response curve of a television i-f strip. Any modern TV i-f has several stages tuned to different frequencies. It's called *staggered tuning*. For example, the input to the first stage may be tuned to 42.4 MHz, the interstage circuits to 43.0 and 44.5 MHz, and the output of the third stage to 45.0 MHz. These four response curves, when the stages are cascaded as TV i-f stages are, appear to line up side by

displayed like this: you can't know exactly the frequency of the peak or of the points where response drops off rapidly. This is particularly important in a curve like the TV i-f response. You need to know *where* certain *precise* frequencies appear on the slope or along the top of the curve.

A *marker generator* and *marker adder* are the instruments for this purpose. At one time, they were separate instruments. Nowadays, the marker adder is part of either the sweep generator or the marker generator.

A marker generator is merely an accurate rf signal generator. Any stable rf generator can be used for marking re-

sponse curves, if it is accurate or easily calibrated.

The best way to use markers is by what's known as *post-injection*. The marker is added to the response curve after demodulation. (The old way was to feed the marker signal right in with the sweep-generator rf; it often upset the tuned circuits and made a false curve.) The sketch in **fig. 7** shows marker adder connections. The instrument is shown separately, but it's usually part of one of the generators. In that case, some of the connections are made internally.

For television, there are multimarker

what's to come

Armed with this information about how a sweep generator is used, you should find a lot of specific jobs for it on the ham bench. You can test and adjust filters, bandpass transformers, critical coupling between windings of transformers you wind yourself. With practice, you'll find the instrument easy to use. It tells you if your alignment job on a receiver (or the frequency conversion adjustment of an ssb transmitter) has produced the intended result. You can test any circuit that's within the rf range of the sweep generator you own.

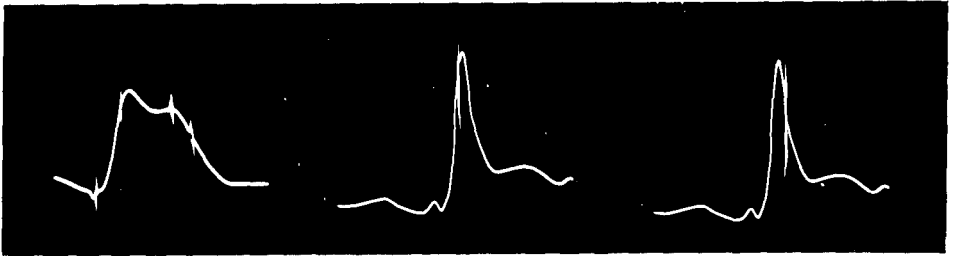

fig. 8. Frequency markers on response curves. On the left the markers are provided with a special marker generator. Markers are used in the two photos to the right to show the bandwidth of the curve.

instruments available, with crystal-controlled marker signals. Such a generator displays markers at several points on the response curve simultaneously. The one at the left in **fig. 8** is an example. Marker frequencies are identified, to give you an idea how they help you recognize the true bandpass of the i-f stages being tested.

The ham-receiver curve in the middle has only one marker. It's labeled, so you know where (in frequency) the down-frequency skirt of the curve is. In actual practice, you find this frequency from the dial of the marker generator. The right-hand photo is the same curve, with a marker at the start of the up-frequency skirt. The frequency spread between the two skirts is the difference between the two marker frequencies. In this case, it's 0.1 MHz. That's the bandwidth of the i-f strip from which this curve is taken.

Therein lies one drawback. None of the units available today go below a center frequency of 3 MHz. So, how do you do anything with 1.8-MHz circuits? Or the 60-, 455-, and 2.2-MHz i-f sections? If you find yourself using a sweep generator, and want to make it useful in this range of low frequencies, drop me a letter or postcard. If there's enough interest, I'll devote this department to that some month.

Next month, I write about mobile power supplies. They've come a long way since the days of the vibrator. Not every ham knows what to do with one when it's bad. Those transistor converter circuits look too complicated.

But they're not, really. Once you understand how and why they work, they seem simple. And fixing them on the repair bench is easy.

ham radio

AMATEUR ELECTRONIC SUPPLY

Make those "S" meters bounce!

You will with
the exciting
new...
Galaxy GT-550



- 550 Watts PEP-SSB, 360 Watts CW
- Highest Powered 80-10 Meter Transceiver in its Class!
- Sharp 2.1KHz filter for minimum QRM and concentrated "Talk Power"
- ALC prevents "Flat Topping" and keeps those S-meters reading High

**FULL
GALAXY LINE
IN STOCK!**

GT-550 80-10m Transceiver	\$550.00
AC-400 110/230v AC Supply	99.95
G-1000 DC Supply	129.95
SC-550 Speaker Console	29.95
RV-550 Remote VFO	95.00
RF-550 RF Console	75.00
PR-550 Phone Patch	49.00
VX-35C VOX Accessory	29.95
CAL-25 25KHz Calibrator	25.00
F-3 300Hz CW Filter	37.50
GTM Mobile Mount	8.95
ZM Floor Adaptor	6.00
R-530 .5-30MHz Receiver	795.00
SC-530 Speaker Console	45.00
FL-5305 500Hz Filter	45.00
FL-53015 1.5KHz Filter	45.00
FL-5306 6Hz Filter	45.00
FM-210 2m FM Transceiver	200.00
AC-210 AC/DC "Booster"	39.95

**AMATEUR
ELECTRONIC
SUPPLY**

4828 West Fond du Lac Avenue
MILWAUKEE, WISCONSIN 53216
PHONE (414) 442-4200

STORE HOURS Mon & Fri 9 to 9; Tues, Wed, Thurs 9 to 5:30; Sat 9 to 3

SAVE \$50

Purchase a GT-550 or R-530 for the regular price, with no trade, and you may take a \$50.00 Bonus Credit toward other merchandise. (\$10.00 Bonus on FM-210)

**To: AMATEUR ELECTRONIC SUPPLY
4828 West Fond du Lac Avenue
Milwaukee, Wisconsin 53216**

I am interested in the following new equipment:

I have the following to trade: (what's your deal?)

Ship me the following New Equipment.

I enclose \$ _____; I will pay balance (if any)

COD (20% deposit) Revolving Charge Plan

Name _____

Address _____

City _____

State _____ Zip _____

Send Reconditioned Equipment Bulletin

AMATEUR ELECTRONIC SUPPLY

AMATEUR ELECTRONIC SUPPLY

AMATEUR ELECTRONIC SUPPLY

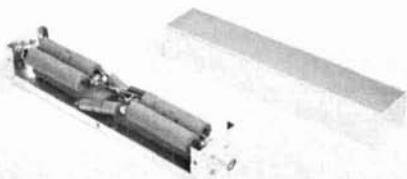

an all-band 10 dB power attenuator

This device can
be used as a
transmitter interstage
buffer or
for isolation when
making antenna
vswr adjustments

Occasionally a situation arises when it is preferable to provide interstage isolation with an attenuator rather than reduce drive to a following stage in a transmitter. For example, an ssb exciter may operate at maximum linearity at some level, say 100 watts. However, when used as a driving source for a transmitting converter, the exciter may cause distortion by overdriving the converter. Reducing input to the exciter will eliminate distortion in the converter at the expense of reintroducing it in the exciter. The buffer attenuator described in this article will resolve the problem, because it allows both units to operate at points of least distortion.

other uses

Many amateurs use a simple reflectometer to measure vswr on the antenna transmission line. The reflectometer is reasonably accurate provided the source impedance doesn't change in response to varying load conditions. Most commercially built rigs and not a few homebrew ones are touchy about transmission-line vswr. When you're trying to match an antenna to such transmitters, a tip-off that something evil is at work is a change in apparent vswr when power level is changed. This is what happens when changing from a-m to cw on some rigs. A 10-dB pad between transmitter and reflectometer will correct this situation

Chet Smith, K1CCL, 2 Jonathan Lane, Bedford, Massachusetts 01730

by stabilizing the transmitter load. In addition, power level is reduced for matching purposes.

circuit description

The circuit is a symmetrical double network (fig. 1). Its symmetrical configuration allows the attenuator to be inserted into the circuit without regard for "input" or "output" orientation.

A prototype circuit was derived from the equations given in reference 1 on the basis of a characteristic impedance, Z_0 , of 50 ohms. The nearest values that could be

used in the second unit (fig. 1B). This unit had an uncompensated vswr of less than 2.0 through 10 meters. The vswr increased to 2.56 on 6 meters (fig. 2). Although the resistors are rated as non-inductive, there was some residual inductive reactance on 6 meters. A small capacitor was shunted across the network to tune out the inductive reactance. The vswr then decreased to 1.5 on 54 MHz, with no measurable change on 160 and 80 meters. Measured characteristics of the final circuit are presented in table 1.

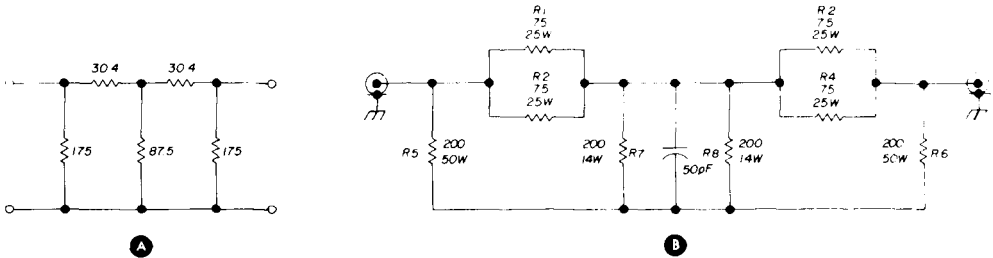

fig. 1. Attenuator schematic. A prototype circuit, A, was built with ordinary power resistors; Z_0 is 50 ohms. Final design, B, uses non-inductive resistors and has a Z_0 of 55.6 ohms. The small capacitor is needed to tune out residual inductive reactance.

- R1-R4 75 ohm, 25 W (Sprague 472E7505)
- R5, R6 200 ohm, 50 W (Sprague 475E2015)
- R7, R8 200 ohm, 14 W (Sprague 459E2015)

construction

The attenuator is housed in a Bud CU3013A enclosure; however any box measuring 1 3/4 x 2 1/2 x 10 inches will be satisfactory. Coaxial receptacles are type SO-239.

The attenuator is sensitive to the

table 1. Measured characteristics of the 10 dB attenuator.

Band	Frequency (MHz)	vswr	excess phase delay* (deg)	insertion loss plus mismatch (dB)
160	1.8	1.22	10.2	10.55
80	3.6	1.24	11.0	—
40	7	1.27	12.2	10.63
20	14	1.33	14.4	—
15	21	1.35	15.2	10.64
10	29	1.48	19.5	10.72
6	54	1.56	21.9	10.8

*Inductive; compensating capacitor could be larger.

obtained from components listed in the catalogs were used. The final version has a Z_0 of 55.6 ohms. Resistors were selected so that the attenuator would dissipate 100 watts in either open- or short-circuit condition.

An attenuation of 10 dB in the line will hold vswr to less than 1.25 regardless of the load impedance. This was achieved fairly closely in practice. It should be noted that the design uses resistors with nearest-available values and is not intended for precision applications.

The first unit (fig. 1A) used ordinary Sprague Koolohm™ power resistors. The inductive effects were quite noticeable on the higher-frequency bands. However, it was usable as a load buffer on 160 and 80 meters (vswr less than 1.5). Probably the reactance could have been compensated on 40 and 20 meters and higher bands.

NOISE BLANKER FOR THE SWAN 250

The TNB-250 Noise Blanker effectively suppresses noise generated by auto ignitions, appliances, power lines, etc., permitting the recovery of weak DX and scatter signals normally lost in noise.

Features include modern solid state design techniques utilizing dual-gate MOS FET transistors and two stages of IF noise clipping for the efficient removal of impulse noise at the transmitter IF frequency. The use of MOS FETs and a special gain controlled amplifier circuit provide excellent cross-modulation characteristics in strong signal locations.



TNB-250 shown installed on a Swan 250 at accessory socket location.

Simplified installation requires twenty minutes.

TNB-250 \$32.95 ppd.

TNB-250C (for Swan 250C) \$32.95 ppd.

Model TNB Noise Blanker, designed to operate with VHF converters by connecting in the coax between converter and receiver.



Noise suppression characteristics are similar to those of the TNB-250. In addition, the ability to handle high intensity pulses of short duration and fast rise time makes the TNB extremely effective in removing radar interference in the 220-1296 MHz bands.

Choice of 14-20, 100-140, or 125-160 VDC, RCA phono or BNC connectors. Specify for 10 or 20 meter converter output.

Model TNB \$29.95 ppd.
(For special frequencies add \$3.00)

Prepaid orders shipped postpaid. (For Air Mail add \$.80) C.O.D. orders accepted with \$5.00 deposit. California residents add sales tax.

All products are warranted for one year and offered on a satisfaction guaranteed or return basis. Technical brochure available.

WESTCOM
ENGINEERING COMPANY
P. O. Box 1504 San Diego, Cal. 92112

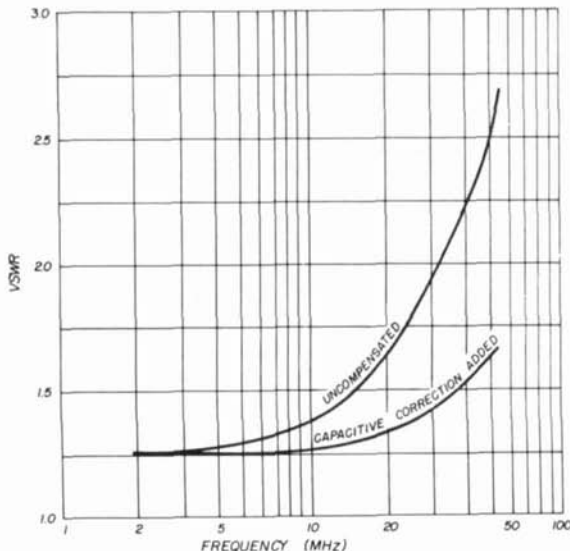

fig. 2. Effect on vswr with and without capacitive compensation.

immediate environment and could not be compensated with the cover removed. The unit was compensated originally with a small variable capacitor, which was replaced with a silver-mica fixed capacitor when the final capacitance value was determined.

cooling

The attenuator was operated continuously with an input of 120 watts for over an hour. It was on a workbench, in the open air, and could be handled without discomfort. The package form factor has a high surface-to-volume ratio, which helps dissipate heat. However, if the unit is to be enclosed, a heat sink or forced-air cooling should be used.

A note of thanks is due to Bill Cobum, W1ELP, who built the attenuators and adjusted the compensating capacitor. Also, I'd like to acknowledge the help of Lee Tibbert, K1YOZ, who made the insertion loss, phase delay and vswr measurements.

reference

¹ *Reference Data for Radio Engineers*, FTC, 3rd edition, P. 158.

ham radio

New Products From THE PHASE CORPORATION



TEST OSCILLATOR

THREE FUNCTIONS IN ONE SMALL PACKAGE
GENERATES PULSE, SAWTOOTH, AND SQUARE

\$34.95

Test your Audio Circuits

FET and Unijunction
Circuitry



Trigger your Logic Circuits
Overlapping Ranges

All Solid-State

Portable and Compact

Specifications:

Frequency:

Saw and Pulse 0.1 HZ — 100 KHZ
Square 0.05 HZ — 50 KHZ

Rise Time

Square and Pulse 0.5 μ Sec.

Pulse Width

1 μ Sec. @ 100 KHZ

Check out your Sweep Circuits

Model 01K (kit with custom case) **\$34.95**

Model 01W (wired and tested) **\$54.95**

FOUR TRACE PRE-AMP

CONVERTS ANY SINGLE TRACE SCOPE TO
DISPLAY UP TO FOUR SIGNALS AT THE SAME TIME

\$34.95

Centering and Gain Controls
for each channel

FET Input



Use as Dual Trace, Three Trace, or
Four Trace

Portable and Compact

Sync. Output

Specifications:

Bandwidth: 1 megahertz/channel

Maximum Input volts per channel: 50 volts p-p

Maximum Output volts per channel: 0.5 volts p-p

Display Time: 50 μ Sec.

Transition Time: 5 μ Sec.

Input Impedance/Channel: 1 meg. ohm

Uses Time Sharing Techniques

Model A1KC (kit with custom case) **\$34.95**

Model A1W (wired and tested) **\$54.95**

SEND CHECK, MONEY ORDER OR ASK US TO BILL YOUR
BANKAMERICARD OR MASTER CHARGE

THE PHASE CORPORATION, Dept. 25
ELECTRONICS DIVISION, MEDFORD, MASS. 02155

PLANNING A NEW SOLID STATE TRANSCEIVER . . . ?

Consider **Walter Schilling Solid State Printed Circuit Modules** for your next home-construction project. Numerous applications: receivers, transmitters, transceivers for HF and VHF. All the hard-to-build, critical circuits. Fully assembled and aligned. Silver-plated glass-epoxy printed circuit boards. Miniaturized, but yet readily serviceable. Made in West Germany.

9 MHz EXCITER for SSB, AM, FM, CW and RTTY.

Three independent, electronically switchable crystal oscillators operating at 9001.5 kHz (LSB), 8998.5 kHz (USB) and 9000.0 kHz (carrier frequency) for AM, FM, CW and RTTY. Carrier oscillator includes varactor diode circuitry for frequency modulation and teletype frequency shift keying. Diode-quad ring modulator for SSB. Crystal filter with two amplifiers. Separate, three-stage microphone amplifier provides audio for SSB and FM modulators, and for external VOX unit (HS 1000 S). HS 1000 C intended for transmitters, HS 1000 D for transceivers (contains steep-skirt crystal filter which can be switched into I.F. chain in "Receive"). Output: 100 Ohms, >100 mV at 9 MHz. Carrier Suppression: >55 dB. Undesired Sideband Rejection: >45 dB. Audio Input: 5 kOhms <0.1 mV. Audio Range: 380-2800 Hz. VOX output: 5 kOhms, 2 V. Power req. 12 V/15 mA. Size: 4" x 3" x 1". 8 transistors, 6 diodes, 3 crystals, 1 crystal filter.

HS 1000 C (transmitter exciter) \$73.15

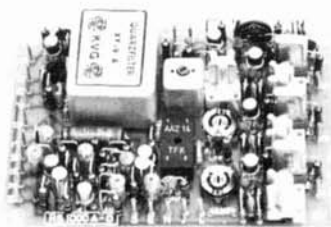
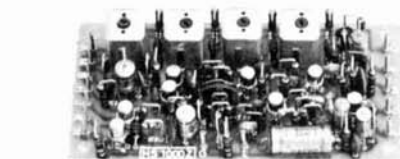

HS 1000 D (transceiver exciter) \$85.53

9 MHz I.F. AMPLIFIER-DEMODULATOR

Three I.F. amplifiers (two of which are AGC controlled), an AM detector, an FET product detector, and a three-stage AGC amplifier with S-meter output. The AGC amplifier and S-meter also serve for transmitter output indication.

Sensitivity: 2 uV. Gain: >90 dB. AGC Range: 65 dB. Bandwidth (-6 dB): 12 kHz. Power req. 12 V/18 mA. Size: 4" x 2" x 1". 7 transistors, 3 diodes.

HS 1000 Z \$28.60

Identical to HS 1000 Z, but with KVG XF 9B crystal filter and electronically switched BFO for USB/LSB. Bandwidth: (-6 dB): 2.4 kHz. Power req. 12 V/22 mA. Size: 6" x 2" x 1". 9 transistors, 3 diodes, 2 crystals, 1 crystal filter.

HS 1000 ZF \$85.50

AUDIO AMPLIFIER

1.4 Watt output audio amplifier for receiver or low-level modulator.

Input: 8.5 kOhms, 2 mV. Output: 5-15 Ohms (no output transformer required), 1.4 W. Distortion: 10% max. Audio Range: 300-5500 Hz. Power req. 12 V/10-200 mA. Size: 1 1/2" x 2" x 1". 2 transistors, 1 diode, 2 power transistors.

HS 1000 NF \$14.30

VOX/ANTI-TRIP MODULE

Complete VOX unit with PTT override and anti-trip provision.

VOX input: 5 kOhms, <15 mV. Anti-trip Input: 2.5 kOhms, <15 mV. VOX Hold-time: 1.5 Sec. Power req. 12 V/60 mA. Size: 3" x 2" x 1 5/8". 4 transistors, 5 diodes, 1 relay (4PDT).

HS 1000 S \$17.60

Also:

HS 1000 E 100 kHz Crystal Calibrator \$19.53

HS 1000 N Regulated Power Supply \$50.88

HS 1000 NS-12V Regulator Circuit \$25.58

HS 1000 NS-25V Regulator Circuit \$25.58

HS 1000 RF NBFM/RTTY Demod \$37.68

HS 1000 T Two-tone Audio Generator \$14.30

AVAILABLE FROM STOCK!

si

SPECTRUM
INTERNATIONAL
BOX 87 TOPSFIELD
MASSACHUSETTS 01983

vswr alarm circuits

Here are some additions
you can make
to your vswr meter
to give aural
or visual warning
of vswr changes

John J. Schultz, W2EEY, 40 Rossie Street, Mystic, Connecticut 06355

When you first put a new antenna into service, you're quite concerned about transmission line standing wave ratio (swr) and carefully note swr meter indications. During regular operation, however, you may glance occasionally at your swr meter, and if it's somewhere in the ball park, you probably don't bother to take an accurate reading.

A drastic increase in swr will cause abnormal transmitter tuning, so a moderate swr increase may not be noticed. But it's important to be aware of any increase in swr for several reasons. A high swr can cause component breakdown in high-power equipment as well as in low-power transmitters where marginally rated components are used. Also, a small but continuous increase in swr may indicate an incipient problem with your antenna or transmission line.

What you need is a circuit that will monitor swr and give an alarm when the swr exceeds a predetermined limit. This article discusses and illustrates a number of swr alarm circuits. All are intended to be used with in-line swr meters of the Monimatch type. In most cases the alarm circuit can be easily built into an swr meter enclosure.

Simple alarm circuits have been emphasized in the literature. You can combine some of these to form more complex alarm systems. Once the general requirements are understood, you may want to develop your own circuit. A large number of voltage- or current-level sensing circuits are shown in electronic circuit design handbooks. These can be adapted as swr alarms.

basic principles

In-line swr meters use a diode circuit to provide a dc voltage proportional to the power in the transmission line in the

forward (incident) and reverse (reflected) directions. A switch allows either incident or reflected voltage to be read on the meter. The meter is calibrated to indicate swr in the reflected voltage position after the meter has been set to full-scale indication in the forward direction.

The loading effect of the meter resistance on the diode circuit reduces the voltage across the meter to a very low value. However, if the diode circuit is lightly loaded, several volts may be produced in the forward or reflected position that can be used to activate an alarm circuit (fig. 1).

With the swr meter switch in the

forward position, an alarm circuit in the reflected-voltage diode output circuit can be set to operate when reflected voltage becomes excessive. If the alarm circuit's input resistance is reasonably high,

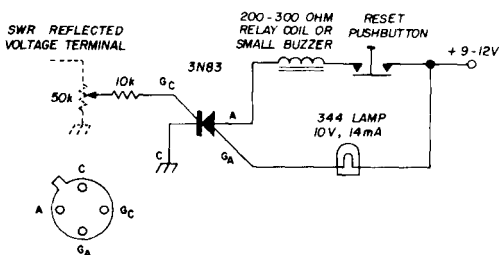

fig. 2. Simple scr latching-type alarm circuit requires only 0.4 to 0.9 volt trigger level.

won't affect normal operation of the swr meter. When the meter is switched to the reflected voltage position, the low meter resistance won't be affected by the alarm circuit.

power and frequency considerations

This simple concept works well and is satisfactory for most situations. It does have some characteristics that should be considered, however. The diode circuit voltage corresponding to a certain swr remains correct only for the transmitter output for which it was originally established. If you usually operate a transmitter at the same power, then there's no problem. But if you use different power levels, the point at which the alarm circuit is activated has to be re-established for each new power level.

Another point to consider is the voltage pickup from the transmission line. It can vary with frequency depending on the pickup method. Some swr circuits will exhibit little variation in voltage pickup when used from 80 to 10 meters, while others will vary 60 dB or more. If there's a wide variation in voltage pickup, you can (a) set the circuit to enable at a narrow swr range on the higher-frequency bands, or (b) readjust the alarm for each band and accept the fact that a greater swr level will be required to activate the alarm on the lower-frequency bands.

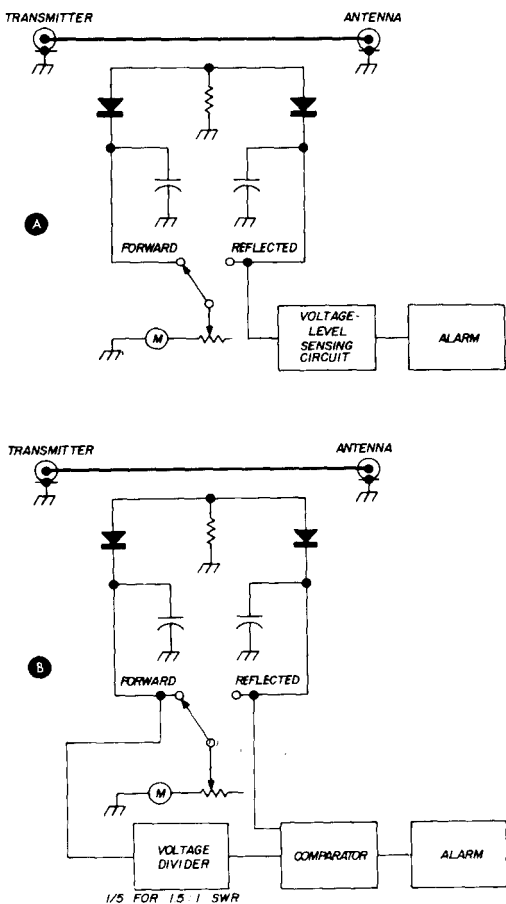

fig. 1. Methods for adding an alarm circuit to an existing swr bridge. Voltage-level sensing circuit, A, is simplest; comparator circuit, B, is effective over a wider range of operating conditions.

comparator circuit operation

If you operate only on one band with a transmitter of constant power level, the simple alarm circuit of **fig. 1A** will

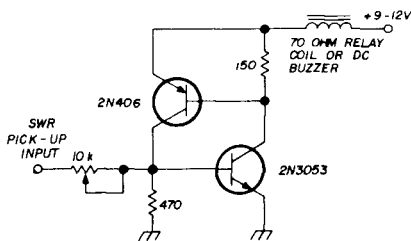

fig. 3. Nonlatching voltage-sensing circuit. Relay will actuate when input voltage exceeds a preset level; 10K ohms potentiometer allows trip level to be set from about 0.4 to 10 volts.

suffice. A slightly more complex approach can be used, however, that eliminates the problem of resetting the alarm for different power levels and different swr meter voltage pickup on different bands. Because the swr is determined by the ratio of reflected-to-forward voltage, you can use a circuit as shown in the block diagram of **fig. 1B**. Here, a voltage divider and voltage ratio sensing circuit (comparator) are combined to provide an alarm that operates irrespective of transmitter power.

Since this ratio is determined by the line swr only, it remains the same for any transmitter power level. The forward and reflected voltage amplitudes change the same with frequency, but their ratio does not. As shown in **fig. 1B**, you can preset the alarm for a specific swr level. For an swr of 1.5, the reflected voltage will be 20 percent of the forward voltage. Thus, if the forward voltage is divided by 1/5 and compared with the reflected voltage, the differences should never be greater than zero unless the chosen swr is exceeded. The comparator monitors the difference between the voltages and produces an alarm whenever a difference occurs.

practical circuits

Practical swr alarms can be divided

into meter-relay, voltage-level sensing and voltage comparator circuits.

The simplest alarm would be a meter-relay with an adjustable trip-point setting substituted for the regular swr meter movement. The relay circuit could be set to trip at some chosen swr level. Commercial meters of this type are available in ranges between 0.50 μ A and 0-1 mA (Simpson 29XA series) but are quite expensive. If you can obtain such a meter at surplus prices, it will provide a very simple and reliable swr alarm. The relay contacts can't handle much current (about 10 mA), but they can be used directly to control an aural alarm device such as the Mallory Sonalert solid-state buzzers.

A simple voltage-sensing circuit is shown in **fig. 2**. A positive level of 0.4 to 0.9 volt at the gate of the SCR will fire it

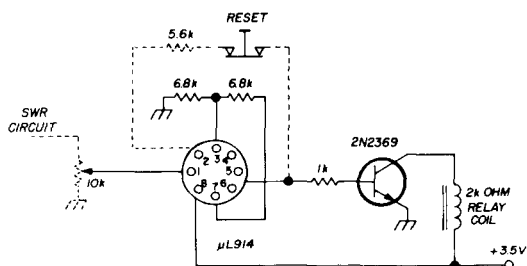

fig. 4. Simple IC relay driver circuit provides positive trip action with input of about 1.3 V. Circuit can be made latching by including components shown in dashed lines.

into conduction. Once fired, it will continue to conduct even if the gate voltage falls. Thus, a reset pushbutton switch is necessary in its anode circuit. The anode circuit can control a relay to activate some sort of alarm device, or a low-voltage dc buzzer can be driven directly. The lamp need not be used if it's not desired. The 10 kilohm resistor in the gate circuit provides very little loading on the swr meter circuit. The 50 kilohm potentiometer sets the reflected voltage level at which the scr will fire.

Fig. 3 shows another voltage-sensing circuit that can be used in a manner

similar to the scr circuit. It's somewhat simpler because it won't lock or latch into a conducting state and, therefore, need not be reset. The transistors are inexpensive; each costs less than a dollar.

This circuit also provides a reasonably high shunting resistance to the swr meter circuit via the 10 kilohm input potentiometer that establishes the voltage level at which the relay coil (or buzzer) will be activated.

Fig. 4 shows still another voltage sensing circuit using an inexpensive $\mu\text{L}914$ integrated circuit. The circuit can be made either latching or nonlatching, depending upon whether or not terminals

divided-down forward voltage level, the audio oscillator produces first a series of beeps. As the voltage difference increases, it produces a steady tone.

Fig. 6 shows a simple alarm using the Fairchild $\mu\text{A}710$ integrated circuit.* The IC comparator drives a 2N1711, which can be used to control an aural or visual alarm. (A pilot lamp in the 2N1711 collector circuit can be used for a visual indicator.) The $\mu\text{A}710$ inputs aren't shown as they would be connected to an swr meter; rather they indicate the basic application of the $\mu\text{A}710$. Its operation is as follows.

When the monitored voltage equals

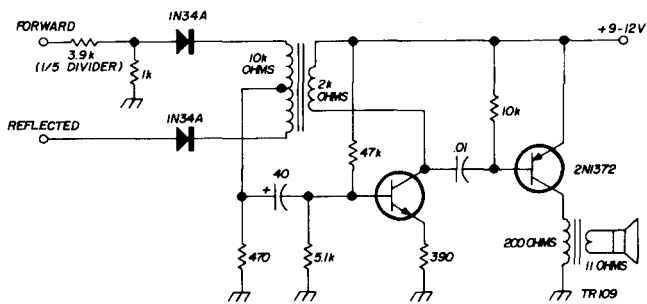

fig. 5. With this circuit an audio alarm is produced when a polarity difference exists between the input voltages.

2 and 6 of the IC are tied together.

In the foregoing circuits, the input voltage level that causes the circuits to operate is affected by the power-supply voltage. Essentially, no current is drawn from the power supply when the circuits are not conducting, so a simple battery supply can be used that will provide a constant voltage. If the voltage is obtained from a non-regulated source, a zener diode regulator should be used.

comparator circuits

Voltage comparator circuits are shown in figs. 5 and 6. The circuit of fig. 5 is complete with an audio oscillator included as the alarm device. One 1N34A diode is coupled to a 1/5 voltage divider (for a 1.5 swr) to the forward-voltage circuit of an swr meter. The other 1N34A diode is connected directly to the reflected-voltage circuit. If the reflected-voltage level becomes greater than the

that of the reference voltage (at pin 3), the voltage at pin 7 goes from zero to about 2-3 volts. When the monitored voltage falls below the reference voltage, pin 7 returns to ground potential. Thus, for an application as an swr alarm circuit, the reference voltage can be obtained as shown in fig. 5 (through a voltage divider from the swr meter forward-voltage circuit). The monitored voltage terminal would be connected to the reflected-voltage circuit.

The applications of the $\mu\text{A}710$ can be extended to many other alarm and control circuit uses. The only restriction is the maximum magnitude of the input voltages it can handle, which is about 7 volts.

*The $\mu\text{A}711$ Dual Comparator (essentially two $\mu\text{A}710$'s in a TO-5 case) costs \$2.50. Available from Poly Paks, Box 942, South Lynnfield, Massachusetts 01940, catalogue number 92CU813. Regular $\mu\text{A}710$'s are \$4.50 each.

adjustment

Assuming the transmission line is matched at a low swr, a voltage-level sensing alarm can be connected to the swr meter reflected-voltage circuit, and the adjustment potentiometer can be set so the alarm is just activated. The potentiometer is then backed off slightly and locked. Any slight increase in swr should then activate the alarm. If you wish to set the alarm more exactly, dummy loads can be used to simulate the swr level at which the alarm will become activated. As mentioned before, this adjustment should be made at full power and reviewed on each

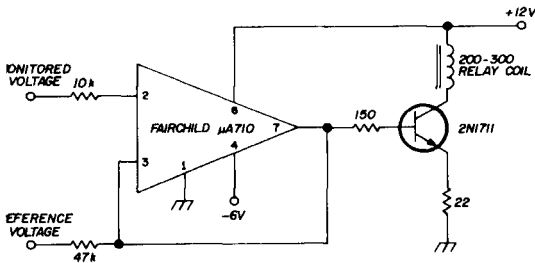

fig. 6. IC comparator is ideally suited for swr monitoring but requires two supply voltages.

band, because it may vary due to the swr meter pickup circuit characteristics.

The comparator circuits shouldn't require much adjustment. However, for exact setting, one leg of the voltage divider from the swr meter forward-voltage circuit should be variable. Then, using dummy load resistors at any reasonable power level to simulate various swr's, the potentiometer leg of the divider should be adjusted to activate the alarm at the desired swr. The loading effect of the voltage divider network may require a loading resistor in the reflected-voltage output circuit.

An added refinement I didn't explore is that of making the alarm self-powered by using the voltage in the forward pickup circuit. This may be practical for very low-current (lamp) alarms. Perhaps some readers might wish to develop this idea.

ham radio

CQ de W2KUW

WE NEED YOUR SURPLUS TUBES

1P21	3CX2500
2C39	3CX3000
2K25	3CX5000
2K48	3CX10,000
2K (any digits)	3E29
3-400	3K (any digits)
3-1000	4-65
3B24	4-125/4D21
3B28	
4-250/5D22	4CX3000A/8169
4-400A/8438	4CX5000A/8170
4-1000A/8166	4CX5000R/8170W
4X150A	4CX10,000/8171
4CX250B	4X150G/8172
4CX250R/7580W	4PR (any digits)
4CX300	5-125B/4E27A
4CX250A/8321	
4CX1000A/8168	
5R4WGB	304TL
6BL6	VA (all types)
6BM6 or 6A	250TH
6L6	450TH
7D21	450TL
8D21	QK (all types)
9C21	715C
9C25	802
75TL	
805	891R
807	TW (all types)
810	TWT (all types)
811A	NL (all types)
812A	4000 series
813	5000 series
832A	6000 series
833A	7000 series
891	8000 series

Please send us your surplus inventory lists. We want to buy other tubes and TX — RX — test equipment.

The TED DAMES Co.

308 HICKORY ST., ARLINGTON, N. J. 07032
Phone: 201 998-4246

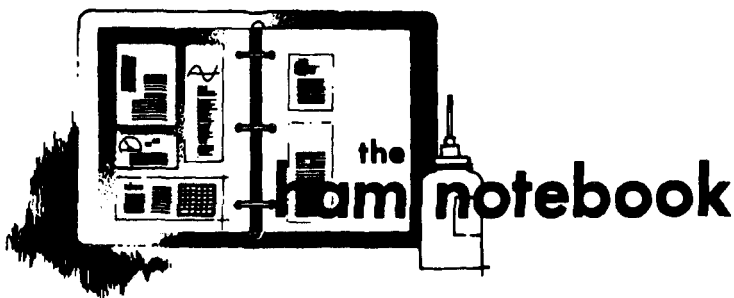

simple grid-block keying

In the May 1969 issue of *Florida Skip*, Dick Blasco, WA4DHU, describes a simple grid-block keying system that should be of interest to cw operators who build their own gear.

The merits of a differential grid-block keying system are discussed at length in many of the standard handbooks. However, most of the circuits described in the literature involve one or more vacuum tubes, many parts, and in general cause the builder to shy away from all that hardware and stick to a simpler, poorer system.

The system shown in fig. 1 is very simple, involves no active elements, and does a nice job of providing true differential keying at minimum cost. It is simply a voltage divider, with a zener diode providing the differential function normally provided by a voltage-regulator tube.

To design the system, determine the proper operating grid voltage and current to place your final amplifier in class-C operation. Resistors R1 and R2 are calculated as follows:

$$R1 = \frac{E_{gg}}{I_{g1}}$$

$$R2 = \frac{R1 \times E_{g1}}{2E_{gg} - E_{g1}} - 1000$$

where E_{gg} is the negative bias voltage, E_{g1} is the final grid bias and I_{g1} is the final grid current.

The zener voltage is chosen by subtracting the vfo bias (key down) from the supply bias, and choosing a zener diode with a breakdown voltage smaller than this value. Several values should be tried to get optimum keying. C1 is chosen by trial and error to get the proper keying waveform, according to your particular taste. D1 is any general purpose diode.

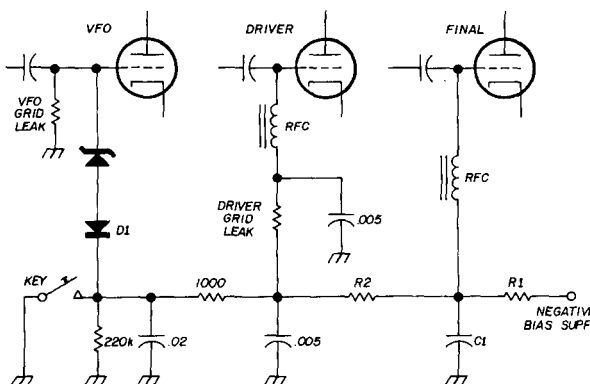

fig. 1. Simple grid-block keying system.

In operation, power amplifier bias falls exponentially as the key is closed. However, at a trigger point well before the driver and final conduct, the zener stops conducting and the vfo is turned full on, while the other stages become operative later (depending on capacitor C1). When the key is released the final and driver gradually turn off, but the vfo remains on until the bias is nearly at its peak value, at

which time the zener conducts, placing bias on the vfo to keep it from oscillating.

The circuit provides a minimum bias on the final of one-half the negative bias supply. This protects the final amplifier stage in case excitation is lost. Be sure that the grid leak in the vfo is at least 4700 ohms.

This circuit is a variation of the design used in the Heath HW-16 transceiver. Existing grid-block keying systems can be made differential by simply adding the two diodes to the vfo grid circuit.

contest keyer

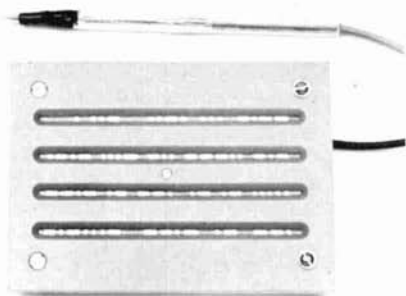

I built this gadget, the Scratch-1 programmable keyer, for the 1969 ARRL Field Day Contest. It was designed to replace an old keyer that used the rectified output of a tape recorder. However, the Scratch-1 offers several advantages: small size, no power connections, variable speed and access to different parts of the message.

Although the basic concept is quite simple, a number of prototypes were

built to find an easy and durable keying system. The unit shown in the photo uses Scotch no. 49 aluminum tape for the keying element. As a preventative measure, a Q-Tip dipped in *NO-OX* (contact cleaner) was run over the keyer contact surface just before the field day contest. The keyer performed perfectly and shows little wear after completing over 300 contacts.

Since the code characters are fairly small, the smoothness of keying is critically dependent on how smoothly the operator can scratch the stylus down the base. I wanted a compact unit so I used quarter-inch dashes, but I would recommend making them a little longer to facilitate smooth operation. This keyer was designed for low-power applications such as grid-block keying — it probably won't take the rigors of cathode keying, particularly in medium-to high-powered transmitters.

Martin Davidoff, K2UB

mobile power supply

The simple mobile power supply shown in **fig. 1**, designed by WN8DJV, uses a low-cost toroidal transformer available from Fair Radio Sales. With no load, typical output is 540 Vdc; 500 Vdc at 50 mA; 480 Vdc at 100 mA; 450 Vdc at 200 mA; and 440 Vdc at 250 mA. Layout is not critical, but be sure you use a good, healthy heat sink for the two power transistors. If you have trouble finding a 3.3-ohm, 5-watt resistor, use three 10-ohm, 2-watt resistors in parallel.

fig. 2. Low-cost mobile power supply designed by WN8DJV uses an inexpensive surplus toroidal transformer available from Fair Radio. (\$3.95, Fair Radio Sales, 1016 E. Eureka Street, Lima, Ohio 45802).

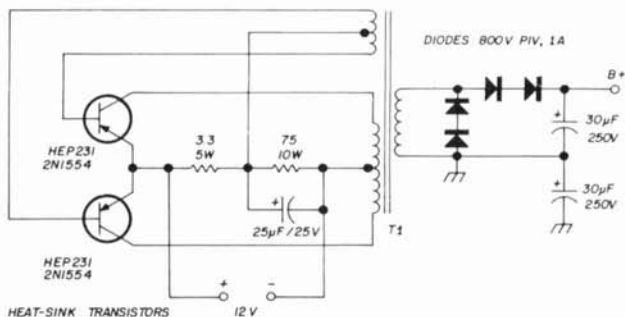

parasitic suppressor

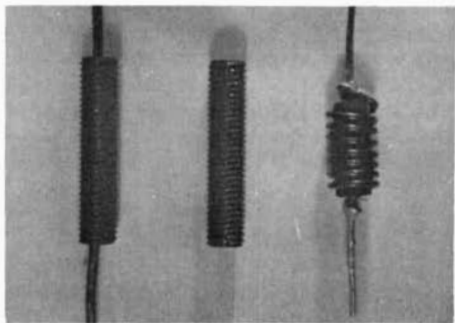

Finding the right parasitic suppressor for a particular circuit can be a frustrating task. As a builder of a homebrew linear amplifier that had severe parasitic problems, I know what I'm talking about. I spent many days trying to suppress the parasitics and I finally came up with a coil-resistor combination that did the job on 80, 40 and 20 but wouldn't come through on 15 or 10. Since three out of five is better than nothing, I left the choke in. After operating for a few months and missing all the action on 15 and 10, I decided to try something else.

At the suggestion of a friend, I installed ferrite beads in the plate leads of my linear; I could not detect the slightest parasitic! Instant suppression. The magic of ferrite* does not stop here. It can be used for rf shielding and decoupling; grids can be shielded from strong rf fields, thus reducing instability.

The surprising thing about these little giants is that almost anyone with even a small junk box has some: they're used in coils and coil forms to increase inductance. The slug itself is about 3/16 inch in diameter and 1 to 1½ inches long.

When you slip a piece of wire through the slug, you create a low-Q inductor. The wire itself has a very small but finite inductance that is multiplied many times

*Although the "beads" suggested by the author are probably powdered iron, and not ferrite, in this particular application the result is the same. Miniature ferrite beads are available from Amidon Associates, 12033 Otsego Street, North Hollywood, California 91607; package of 12 beads with a spec sheet and application notes is \$2.00.

by the permeability factor of the slug, which is 900 or so. Although the inductance is still quite small, it's enough to suppress vhf parasitics.

Jim Barcz, WA9JMY

rectifier terminal strip

Recently, while trying to find a suitable terminal strip for a bridge rectifier that used 8 diodes (2 in each leg), I decided to use an inverted octal socket. These sockets are fairly compact, and the diodes can be physically arranged similar to their schematic equivalent. This simplifies connections and eliminates costly wiring errors. One caution however: do not mount the socket directly to the chassis; use a bracket or standoffs since the contacts on some sockets can slide out the top of the socket and short the diodes to the chassis.

Robert G. Wheaton, W5PKK

earth currents

Is the conversation in your evening QSO dragging? If so, here's something you can rig up in about five minutes that will open the door to all kinds of conversational possibilities. It is commonly known that the earth's magnetic field sets up currents that flow through the ground. What is not usually known is that these currents can be measured with the simplest of setups: a 50- or 100- μ A meter, two pieces of brass welding rod and some wire.

Drive the rods into the ground 30 to 60 feet apart on an east-west line. Connect a wire to each. Hook the eastern rod to the positive meter terminal, the western rod to the negative. When the wires are first connected, the meter reading will be high because of galvanic action on the rods; after a few minutes the currents will drop to the normal value. If the meter reads down scale, install a reversing switch rather than changing the meter connections because earth current may reverse itself occasionally; or, use a 50-0-50 center-zero meter.

Different parts of the country have widely varying readings. It has been noted

TAKE YOUR PICK

These units will replace the 100 kHz calibrator built into most receivers. Using your 100 kHz crystal this unit will provide sharp accurate markers with readouts at 100 - 50 - 25 - 10 and 5 kHz usable thru 50 MHz. Keep your receiver calibrated at all times, locate sub bands, MARS frequencies and band edges.



or



Frequency marker, less cabinet and switch

Specifications: Glass Epoxy Board. Adjustment to zero beat with WWV. Uses 100 KHz crystal (not supplied). 3 to 4 VDC. Compact — 1.75 x 3.75 inches. Install anywhere!

Complete easy-to-assemble kit \$16.50 **Wired and Tested \$19.95**

SWITCH \$1.00 CRYSTAL ONLY \$3.50
with purchase of any of above

SELF-CONTAINED UNIT

The TBL 1 Marker is a complete unit including the circuit board shown at left and powered with 3 "C" type flashlight batteries. Merely connect to your receiver antenna — no internal wiring necessary. A front panel control allows zero beat with WWV.

Special introductory price **\$29.95**
Less crystal and batteries

POSTPAID U.S.A.

SOLD WITH MONEY BACK GUARANTEE

THE RADIO SHOP, LAB 1

48 ELM STREET, NEW CANAAN, CONN. 06840 — Tel. 203-966-3553

HAL DEVICES



Your only source for new semiconductor devices and components at lower than surplus prices.



Semiconductor Devices

Fairchild μ L 914 or 900 (8 pin epoxy TO-5)60 ea.
Fairchild μ L 923 (8 pin epoxy TO-5)90 ea.
Texas Instr. SN 72709N on amp (Dual Inline)	\$2.00 ea., 6/\$10.00
Hewlett Packard 2800 Hot Carrier Diodes90 ea., 12/\$10.00
Motorola 2N5401 PNP 150v, 600 ma90 ea.
Motorola 2N5655 NPN 250v, 500 ma90 ea.
HAL Designer Cabinets, 3 sizes	\$2.85 to \$6.25
Resistors, 2.2 Ω to 2.2 M Ω (1/2 w, 10%)05 ea.
Mixed quantity price:	10/40, 100/\$3.50

Mercury wetted reed relays (unused)
6, 12 or 24 v DC coils, SPDT \$3.00, DPDT \$3.50

Electronic Keyers, \$16.00 to \$46.50

Add postage; excess refunded

HAL DEVICES

Box 365 H, Urbana, Illinois 61801

... THE BEST 2 METER CONVERTER

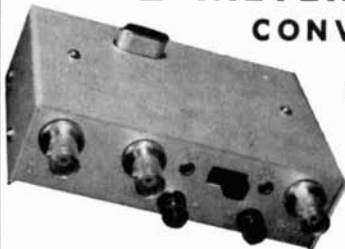

Model 407

\$39.95
ppd.

144-146 MHz in. 28-30 MHz out
or 146-148 MHz with a second crystal
available for \$4.95 extra

A full description of this fantastic converter would fill this page, but you can take our word for it (or those of hundreds of satisfied users) that it's the best. The reason is simple — we use three RCA dual gate MOSFETs, one bipolar, and 3 diodes in the best circuit ever. Still not convinced? Then send for our free catalog and get the full description, plus photos and even the schematic.

Can't wait? Then send us a postal money order for \$39.95 and we'll rush the 407 out to you. NOTE: The Model 407 is also available in any frequency combination up to 450 MHz (some at higher prices) as listed in our catalog. New York City and State residents add local sales tax.

VANGUARD LABS

Dept. R, 196-23 Jamaica Ave., Hollis, N.Y. 11423

BACK ISSUES

1968-1969

3 for \$1.00

OUR CHOICE — NOT YOURS
REGULARLY 75¢ EACH

HAM RADIO
GREENVILLE, NH 03048

at several installations near my home that erratic and fluctuating meter readings seem to precede an aurora opening on 6 or 2 meters. It is interesting to note that weather also has some effect on the reading; if the ground is wet the readings will usually be slightly higher. Magnetic storms have a noticeable effect.

One important note; be sure to put a .01 μ F bypass capacitor across the meter terminals to eliminate the effects of rf or stray 60 Hz current.

Don Samuelson, W7OUI

coaxial-line resonators

Transmission lines made of coax, twin-lead or "plumbing" are often used in vhf, uhf and microwave equipment. They can be used as (or in) filters, as tuning elements in amplifiers or oscillators, and as replacements for inductors or capacitors in tuned circuits. At frequencies over 100 MHz or so, transmission lines can be of practical lengths, and they exhibit high efficiencies and excellent performance

The electrical length, l , of a transmission line is easily found:

$$l = \frac{l_p}{V}$$

Where l_p is the physical length in meters, and V is the velocity factor (1 for air, 2/3 for common coax, 4/5 for small 300-ohm twinlead). Or for lengths in feet:

$$l = \frac{3.28 l_p}{V}$$

The actual wavelength in meters is also easily determined:

$$\lambda = \frac{300}{f}$$

Where f is the frequency in megahertz. For example, a coax line shorted at one end is 1 meter long. What is its electrical length at 6 meters? Since V is 2/3 for common coax,

$$l = \frac{l_p}{V} = \frac{1}{2/3} = 3/2$$







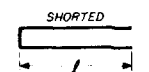

ELECTRICAL LENGTH, l →	l LESS THAN $\frac{\lambda}{4}$	$l = \frac{\lambda}{4}$	$\frac{\lambda}{4} < l < \frac{\lambda}{2}$	$l = \frac{\lambda}{2}$
SHORTED 	 INDUCTIVE	 PARALLEL RESONANT (HIGH Z AT F)	 CAPACITIVE	 SERIES RESONANT (LOW Z AT F)
OPEN 	 CAPACITIVE	 SERIES RESONANT	 INDUCTIVE	 PARALLEL RESONANT

fig. 3. Electrical properties of transmission-line resonators.

and reproducibility, unlike some circuits using conventional lumped capacitors and inductors.

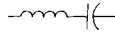
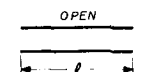
Unfortunately, it is sometimes hard to remember which type of transmission line exhibits which characteristics. To help out, table 1 summarizes the properties of shorted and open lines in terms of electrical length. The table lists wave lengths only between zero and $\lambda/2$, but the addition of $\lambda/2$, or any multiple of $\lambda/2$, does not change the properties.

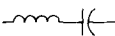
The electrical length is 1.5M, so is one-fourth wavelength ($\lambda/4$) and acts as a parallel-tuned resonant circuit.

The transmission line can be loaded with a capacitor for tuning or to shorten the necessary line length. The effect of the capacitance depends on line impedance, location of the capacitor, frequency, etc. Either experimentation or consultation of a reference containing details will help out here.

Paul Franson, WA7KRE

PRESENTING THE ALL NEW AMECO PT ALL BAND TRANSCEIVER PREAMPLIFIER



■ 6 THRU 160 METERS ■ FEEDS 2nd RECEIVER

Model PT, with built-in power supply, transfer relay, connecting cables, wired and tested. Amateur Net\$59.95

- A frame grid pentode provides low noise figure with ability to handle strong signals, greatly improving the sensitivity of the receiver section of a transceiver.
- A unique built-in transfer circuit enables the PT to by-pass itself while the transceiver is transmitting. The PT also feeds the antenna input of a 2nd receiver as well as muting it.

AMECO

DIVISION OF AEROTRON, INC. ■ P. O. BOX 6527 ■ RALEIGH, N. C. 27608



Radio Amateurs
Reference Library
of Maps and Atlas

WORLD PREFIX MAP— Full color, 40" x 28", shows prefixes on each country . . . DX zones, time zones, cities, cross referenced tables . . . postpaid \$1.00

RADIO AMATEURS GREAT CIRCLE CHART OF THE WORLD— from the center of the United States! Full color, 30" x 25", listing Great Circle bearings in degrees for six major U.S. cities; Boston, Washington, D.C., Miami, Seattle, San Francisco & Los Angeles. . . . postpaid \$1.00

RADIO AMATEURS MAP OF NORTH AMERICA! Full color, 30" x 25" — includes Central America and the Caribbean to the equator, showing call areas, zone boundaries, prefixes and time zones, FCC frequency chart, plus informative information on each of the 50 United States and other Countries . . . postpaid \$2.00

WORLD ATLAS — Only atlas compiled for radio amateurs. Packed with world-wide information — includes 11 maps, in 4 colors with zone boundaries and country prefixes on each map. Also includes a polar projection map of the world plus a map of the Antarctica — a complete set of maps of the world. 20 pages, size 8 3/4" x 12" postpaid \$2.00

Complete reference library of maps — set of 4 as listed above postpaid \$3.00
See your favorite dealer or order direct.

**WRITE FOR
FREE
BROCHURE!**

RADIO AMATEUR
callbook INC.
Dept. E. 925 Sherwood Drive
Lake Bluff, Ill. 60044

NEED CRYSTALS?



**48 Hr.
DELIVERY**

We can supply crystals from 2KHz to 80 MHz in many types of holders.

SPECIALS

Color TV crystal (3579, 545KHz) wire leads	\$1.60	4 for \$5.00
100KHz freq. std. crystal (HC13/U)	4.50	
1000 KHz freq. std. crystal (HC6/U)	3.50	
Any CB crystal TR. or REC.	2.25	
Any amateur band crystal (except 80 meters) in FT-243 holders	1.50	or 4 for \$5.00
Any marine frequency (HC6/U)	2.85	
80 meter — FT-243 holders	2.50	

We have in stock over six million crystals which include types CR1A/AR, FT243, FT241, MC7, FT249, HC6/U, HC13/U, HC25/U, HC18/U, etc. Send 10¢ for our 1970 catalog with oscillator circuits, listing thousands of frequencies in stock for immediate delivery. (Add 10¢ per crystal to above prices for shipment 1st class mail, 15¢ each for air mail).



Special Quantity Prices to Jobbers and Dealers.

ORDER DIRECT
with check or money order to

2400H Crystal Drive
Fort Myers, Florida 33901

new products

six-band receiver



Lafayette Radio has announced a new solid-state six-band amateur-band receiver that incorporates three field-effect transistors and two mechanical filters to assure high selectivity with superior rf overload and noise suppression. The built-in power supply permits operation on either 117 Vac or 12 Vdc. Sensitivity is better than 1 μ V on 80, 40 and 20 meters, 0.5 μ V on 10 and 15 meters, and 2.5 μ V on 6 meters. The double-conversion design uses a first i-f at 2.608 MHz and second i-f at 455 kHz; image rejection is better than 40 dB. Audio output impedance, 8 and 500 ohms; audio power, 1 watt; antenna input impedance, 50 ohms. \$149.95. For more information, write to Lafayette Radio Electronics, 111 Jericho Turnpike, Syosset, L. I., New York 11791.

rf power transistors

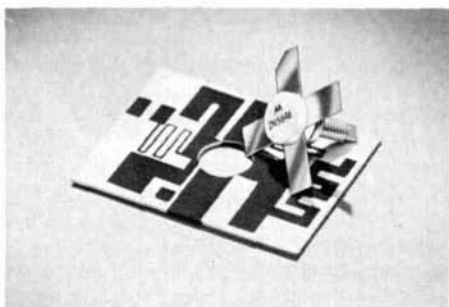

Motorola Semiconductor has announced a new line of balanced-emitter rf power transistors that can provide 12 watts at 450 MHz with a 12.5-volt power supply. The new transistors, the 2N5644 through 2N5646, are intended for use as power amplifiers for the commercial uhf mobile fm band, but are also suitable for amateur applications on 144,220 and 432 MHz. Since these devices are specifically designed for operation from 12.5 volts, no dc-to-dc converter is required.

The 2N5646 family is supplied in the popular 3/8-inch ceramic stripline opposed-emitter package. Low-inductance leads provide easy design and adjustment, especially in broadband circuitry. An important feature of the new transistors is their balanced-emitter construction: each device is composed of many monolithic transistors in parallel with a nichrome resistor in series with each emitter. If emitter current tends to increase in any one of the transistors, the rise in voltage across the emitter resistor decreases base-emitter voltage, reducing the current flow. The equivalent resistance of all the resistors is very low, so they don't cause significant degeneration. Because of the balanced-emitter construction these transistors are very resistant to damage from mismatched loads or detuning. For more information, contact the Technical Information Center, Motorola Semiconductor Products, Inc., Box 20924, Phoenix, Arizona 85036. A similar line for 25 watts output is under development.

flea market



■ **RATES** Commercial Ads 25¢ per word; non-commercial ads 10¢ per word payable in advance. No cash discounts or agency commissions allowed.

■ **COPY** No special layout or arrangements available. Material should be typewritten or clearly printed and must include full name and address. We reserve the right to reject unsuitable copy. **Ham Radio** can not check out each advertiser and thus cannot be held responsible for claims made. Liability for correctness of material limited to corrected ad in next available issue. Deadline is 15th of second preceding month.

■ **SEND MATERIAL TO:** Flea Market, Ham Radio, Greenville, N. H. 03048.

HQ180AC: AM, CW, SSB, RTTY. Latest model. Perfectly mint, only 3 weeks old, \$375.00. Mike Match, Jr., 11001 Ewing Ave., Chicago, Ill. 60617. Call: (312) 768-3099.

APRIL SHOWERS may bring May flowers, but they also bring thoughts of the Hudson Division Convention, October 17-18, Hilton Motor Inn, Tarrytown, N. Y. Exhibits, Lectures, Contests, Gabfests, New York City Sightseeing, Fun. You won't need an umbrella. Get all the facts from Hudson Amateur Radio Council, Box 58, Central Islip, New York 11722.

TMC GPR-90 Receiver, \$250. **TMC MSR-4** Receiving Mode Adapter, \$100. **HR-10** Receiver, \$50. **HX-11** Transmitter, \$25. **Robert Clauser**, 1114 Sandhill Road, Lebanon, Pa. 17042.

FOR SALE: Poly-Comm 2m transceiver, \$100.00 T43GGV 2m FM, \$100.00. FDFM-2S 2m FM transceiver, \$200.00. **George Preston**, 66 Baker Ave., Beverly, Mass. 01915.

SOLID-STATE HEATH SB301. Dual-gate Mosfet's, I.C.'s, and silicon transistors. Converted manual and schematic available. Best offer over \$200. **Clark Hatch, K0KED**, Route 3, Salina, Ks. 67401.

RGBU COAX, low loss foam Amphenol, 10¢ ft. K-200 RG86U, 20¢ ft. PL259-SO239, 40¢ each. **FOB Monte Southward**, R. 1, Upper Sandusky, Ohio 43351.

WORLDS ONLY copyrighted non-profit awards directory. \$3.50 to K6BX, P.O. Box 385, Bonito, Calif. 92002. **Sponsors CHC, FHC & SWL-CHC organizations.**

SAVE. On all makes of new and used equipment. Write or call **Bob Grimes**, 89 Aspen Road, Swampscott, Massachusetts, 617-598-2530 for the gear u want at the prices u want to pay.

MOTOROLA, HIGH BAND: (12) U43GGT, T supply 6146, \$185; (2) T51AAD, twin v, 30w, \$80; (10) 80D's some need repairs \$40 to \$80; each with accessories, less speakers; (35) P-8629 Quick Call Decoders with reeds, \$10 ea. \$7 ea 10 or more. Pick up N. Y., N. Y. or Hartford, Ct. \$20 for shipping **COD: Konax Technical Labs, P.O. Box 587, Manchester, Ct. 06040.**

JOHNSON THUNDERBOLT linear amplifier CW, AM, SSB, DSB, 2000 watts, PEP 1000 watts CW. This rig has less than 20 hrs oper. time. Orig. carton \$350.00. You ship. **Ben W. Themoss**, 310 Seaward Ave., Bradford, Pa. 16701. 814-362-3365.

LAMBDA VR SUPPLIES: 100-200 VDC @ 100 MA. 6.3 VCT @ 3 amp; 200-325 VDC @ 100 MA. 6.3 VCT @ 3 amp, \$25 each. 100-200 VDC @ 300 MA. 2 ea. 6.3 VCT @ 5 amp; 200-325 VDC @ 300 MA. 2 ea. 6.3 VCT @ 5 amp; \$65 each. Variac, 220V @ 31 amp, \$65. Kepco VR supply, Variac-controlled to 1800 VDC @ 200 MA, 23" cabinet, \$100. Line filter, 15 amp 3-wire, 220 VAC, \$10. Transformer, 115/1300 VAC @ 3.0 amp, FB for doubler, 2 ea. @ \$25. Capacitors: 400 MF/330 VDC (14 ea.), 500 MFD/310 VDC (10 ea.), 1.50 ea. 60K MFD/5 VDC, 17.5K MFD/25 VDC, 18K MFD/35 VDC, 8K MFD, 75 VDC, \$1.00 ea. Half-price: Stancor P3060, P6302, P6309, P6315, P8311. PC8401, C1402, C1646, P8026; UTC S44, S45, S49, S57, LS121Y; Triad P18A, F10U, F47U, F26X. 115/12.8 VCT @ 20 amps with 2.5 amp Variac, \$16. **James Craig, W1FBG**, 29 Sherburne Avenue, Portsmouth, N. H. 03801.

1916 QST's wanted. Especially May and June. Any unreasonable price paid! **Ted Dames, W2KUW**, 308 Hickory Street, Arlington, N. J. 07032.

NORTHERN CALIFORNIA Hams: Best deals — new and reconditioned equipment. Write or stop for free estimate. **The Wireless Shop**, 1305 Tennessee, Vallejo, California 94590.

TUBES — Lowest World price. Foreign-American. Obsolete, current. Receiving, Special Purpose. Transmitting tubes. Send for tube and parts catalog. **United Radio Company**, 56-HR Ferry Street, Newark, New Jersey 07105.

REPAIR AND CALIBRATION SERVICE. Write for shipping instructions. **Pantronics of Va., Inc.**, P.O. B. 209, Annandale, Virginia 22003.

NCX-3, HP-13 \$150 no VOX. **E. P. Rolek**, 1166 Ridge Rd. E., Rochester, N. Y. 14621.

ORIGINAL EZ-IN DOUBLE HOLDERS display 20 cards in plastic, 3 for \$1.00, 10 for \$3.00 prepaid. Guaranteed. Patented. Free sample to dealers. **Tepabco, John K4NMT**, Box 198R, Gallatin, Tennessee 37066.

PLATE TRANSFORMER Thordarron 25P83. Primary 115/230, 60 CPS. Secondary 1800 CT, tapped at 1470 CT at 250 MA. New \$8.50. Weight 14 lbs. Please include postage. Free catalog. **R. W. Electronics, Inc.**, 4005 West Belmont Ave., Chicago, Illinois 60641.

NEMS-CLARKE, CFI, DEI and other special purpose receivers wanted. Send accurate description of what you have to **Tucker Electronics**, P. O. Box 1050, Garland, Texas 75040.

CRT'S WANTED: 7AQ7 and SC2799P11. **Wayne W8TGL**, R.F.D. 2, Box 305, Fairmont, W. V. 26554.

QSL. SECOND TO NONE. Same day service. Samples Airmailed 25¢. **Ray, K7HLR**, Box 331, Clearfield, Utah 84015.

PRESS CARD — join International Amateur Radio Journalistic Society, IRS tax-exempt organization. P.O. Box 13522, Tampa, Florida 33611.

TOROIDS 44 and 88 mhy. Unpotted, 5 for \$1.50 ppd. **W. Weinschenker**, Box 353, Irwin, Pa. 15642.

QSLs. SECOND TO NONE. Same day service. Samples airmailed 25¢. **Ray, K7HLR**, Box 331, Clearfield, Utah 84015.

GREENE DIPOLE CENTER INSULATOR . . . see ad page 96, September 1969 Ham Radio.

CONVERTERS. Ameco 6 & 2 meters navistor, \$30. each. **Cloviss Womack**, 11510 North Oaks, Austin, Texas 78753.

RAGS HAMFEST. Syracuse, New York, April 11, 1970 at Song Mountain, Box 88. **Liverpool**, New York 13088.

COMMERCIAL LICENSE EXAMS: Second \$18.00; First \$24.00; Sample questions; Price list \$1 refundable. **Ebcoc Enterprises**, P. O. Box 432, Sparks, Nevada 89431.

rf amplifier ic

Motorola's new MC1590 rf/i-f amplifier features more than 20 dB increase over previous ic amplifiers in rf power gain (45 dB typical at 60 MHz) and agc capability (60 dB minimum from dc to 60 MHz). The high gain and wide-range agc are especially useful in portable receivers where wide ranges of signal levels are encountered. The wide-range agc allows the device to be used in the audio range as a speech compressor; it can also operate as a general-purpose amplifier up to 150 MHz.

The agc function has negligible effect on the i-f passband response because the input and output impedances of the device remain essentially constant during agc operation. For more information on the new MC1590, write to Technical Information Center, Motorola Semiconductor Products, Inc., Box 20924, Phoenix, Arizona 85036.

Kvg crystal filters

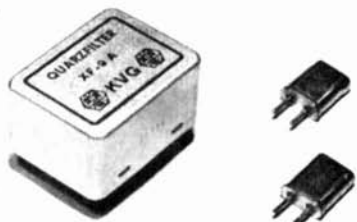

The KVG company of West Germany is a major supplier of amateur and commercial crystals and crystal filters in Western Europe; you see them used in much of the amateur radio equipment built and advertised in the European amateur magazines. The KVG line of high-quality high-performance 9-MHz crystal filters and matched oscillator crystals for ssb, a-m and cw are now offered in the United States and Canada through Spectrum International.

Currently, six filter models are available: the XF-9A 2.5-kHz bandwidth filter for ssb transmitters (\$21.95), the XF-9B 2.4 kHz bandwidth filter for ssb receivers

and transceivers (\$30.25), the XF-9C 3.75 kHz and XF-9D 5.0 kHz bandwidth filters for a-m (\$32.45), the XF-9E 12.0 kHz filter for fm (\$32.45) and the XF-9M 0.5 kHz bandwidth filter for cw (\$23.00). Matching miniature HC25/U oscillator crystals for ssb operation (with the XF-9A and -9B filters), and cw heterodyne as well as 9.0 MHz a-m/cw carrier are \$2.75 each and supplied complete with socket and socket fastener. For complete specifications on these crystals and crystal filters write to Spectrum International, P. O.Box 87, Topsfield, Massachusetts 01983.

crank-up antenna masts

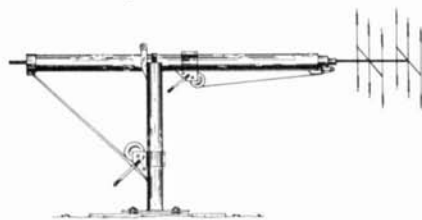

The Tristao Tower Company has introduced a new series of self-supporting crank-up masts that are built from telescoping sections of high strength tubing. The *magna mast* — the larger of the two series — features self-supporting construction with rotor bases, cabling for uniform raising of section, geared raising winches with automatic brakes for maximum safety and one-man installation with a swing-over design that permits antenna servicing at ground level (no ladder or service platform required). The *magna mast* comes in two different sizes: 49 feet and 66 feet. Each is designed to support 12 square feet of antenna in 60 mph winds.

A smaller version of the self-supporting rotating masts is called the mini mast and is available in 30- or 35-foot heights. This mast will support 6 square feet of antenna in 50 mph winds. For more information on these new self-supporting crank-up masts, write to the Tristao Tower Company, P.O. Box 115, Hanford, California 93230, or Olympic General Corporation, P.O. Box 64398, Los Angeles, California 90064.

WONDERFUL WORLD OF CHC INFO. send SASE to Secty. P.O. Box 385, Bonita, California 92002. Membership and services free to blind & paralyzed.

QSL'S — BROWNIE W3CJI — 3111-B Lehigh, Allentown, Pa. 18103. Samples 10¢. Cut catalogue 25¢.

FOR SALE: HEATH MOHAWK receiver \$100; DX-60 \$50; HG-10 \$25 or all for \$150. John L. Parker, WB6DXX, 5008 Greenbrier Avenue, Bakersfield, California 93306.

NOVICE CRYSTALS: 40-15M \$1.33, 80M \$1.83. Free flyer. Nat Stinnette Electronics, Umatilla, Florida 32784.

WORLD QSL BUREAU — see ad page 93.

POLICE — FIRE — AIRCRAFT — MARINE Calls on your broadcast radio with TUNAVERTER S! Tunable — Crystal! Brochure. Salch Company, Woodsboro HMC, Texas 78393.

SWAN 350 wanted, also 406-B VFO. W6YO, 1416 7th Avenue, Delano, California 93215.

TOROIDS! Lowest price anywhere. 40/\$10.00 POSTPAID. 88 or 44 mhz. center tapped (5/\$2.00). FRXD10 typing reperferator and TD on same base \$25 (write for description) Mite page printer \$160. Fresh reperferator tape \$10/case/40. Facsimile paper (electrosensitive) \$3/box/250 sheets/pkg. HQ140X \$90 DRAKE 2B \$150. Johnson 6N2 \$70. Lorenz complete ASR page printer (all 60 speed) \$100. Descriptions for stamp. Stamp for list. Wanted: model 28 teletype equipment. Van, W2DLT, 302H Passaic Avenue, Stirling, N. J. 07980.

ROCHESTER, NY is again Hamfest, VHF meet and flea market headquarters for largest event in north-east, May 16, 1970. Write WNY Hamfest, Box 1388, Rochester, NY 14603 for program and information.

SELL HT-37 — \$169.95; National NC300 Two and Six converters, Speaker, matching cabinets \$139.95. Both look and operate like new. Lem Holland, W4Q1, (919) 742-2280, Siler City, N. C. 27344.

MOTOROLA (DIP) MC790P \$1.90, 10/\$18.00; MC789P, MC724P, \$1.05, 10/\$9.50. Guaranteed. Add postage. HAL Devices, Box 365H, Urbana, Illinois 61801.

WORLD RADIO'S used gear has trial-guarantee! DuoBander 84 — \$99.95; HW22 — \$79.95; HW32 — \$79.95; NCX3 — \$159.95; Swan 250 — \$199.95; 350 — \$279.95; Galaxy 30 — \$139.95; HT32 — \$199.95; 200V — \$399.95; SX101 — \$159.95; HQ170 — \$179.95; Drake 2A — \$159.95; 2B — \$179.95; HRO50 — \$129.95. Free "blue-book" list for more. 3415 West Broadway, Council Bluffs, Iowa 51501.

THE ELEVENTH ANNUAL NEW YORK STATE Southern Tier Hamfest sponsored by the IBM Amateur Radio Club, QCWA, AREC, and Binghamton Amateur Radio Club will be held on April 18, 1970 at St. John's Memorial Center in Johnson City, NY, starting at 2:00 p.m. Adult tickets \$4.75 and student tickets \$2.50. Advance sale only. Closing date on ticket sales is April 15th. Afternoon activities include speeches, displays and contests. Surprise events throughout the day. Banquet/dinner promptly at 7:00 p.m. Tickets and full particulars may be obtained from Frank Gyidik, K2CWD, 509 Torrance Ave., Vestal, NY 13850, phone 785-6220. Don't miss it!

LINEAR IC'S uA703 RF/IF amplifiers 90¢ each, 10/7.50, uA709 \$1.75 each, 5/\$7.50 pp with spec sheets and application information. Send for low prices on many others. Teletec Associates, P.O. Box 903, Mtn. View, CA 94040.

WANTED: USED DRAKE TR-4, blanker preferred, AC-4 and DC-4. Perfect operating condition wanted. State price. WIFE, Skip Colton, 222 North St., Windsor Locks, Conn. 06096.

YOUR AD belongs here too. Commercial ads 25¢ per word. Non-commercial ads 10¢ per word. Commercial advertisers write for special discounts for standing ads not changed each month.

Pro-key Kit



Send perfect morse code — from 5 to 50 words per minute. Excellent to build up your code speed — anyone can send practice code.

- Self-completing characters with automatic character spacing.
- Precision kit includes all parts, such as metal case and printed circuit boards, and detailed, illustrated instructions.
- Pre-assembled keyboard with standard type-writer key arrangement and spacing.
- Self-contained battery operated — two standard "D" cells. All solid state.
- Built-in sidetone and speaker, fast acting relay output.

Basic Pro-Key Kit \$149.50 pp
 Added Buffer Storage Kit \$34.50 pp
 (See March '70 issue — Ham Radio Magazine)

Micro-Z Co.

Box 2426 Rolling Hills, Calif. 90274

FILAMENT CHOKE

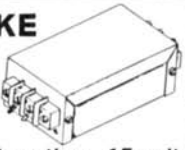

Shielded high reactance at all frequencies above 3 mc. Current capacity of 30 plus amps. Voltage drop at 21 amps is less than .15 volt. Size 2 1/4 wide x 1 1/2 high x 5 1/4 long. Pa. residents add 6% sales tax.

Price \$7.95 ppd. U.S.A.

M. WEINSCHENKER K3DPJ
 BOX 353, IRWIN, PA. 15642
 DEALER INQUIRIES INVITED

HAMFEST '70
 MAY 2 & 3, 1970

This ad with \$1.00 entitles you to a chance on a

DRAKE TR4 TRANSCEIVER
AC4 POWER SUPPLY

NAME _____

BRARC HAMFEST COMMITTEE
 P. O. BOX 53194
 BATON ROUGE, LA. 70805

wall plaques



If you want to dress up your operating room, or if you're looking for a gift for another amateur, a hand-carved monkey-pod call-letter plaque like that shown above is an ideal solution. These handsome plaques are handmade in the Philippine Islands and are available with 4, 5 or 6 letters. The letters are about 5 inches high and the plaques are 8 inches high, 20 inches long and nearly 1 inch thick (five-letter plaque). The four-letter plaques are 17 inches long; the six-letter plaques, 22 inches. The price of the four-letter plaque is \$11.30 five-letter, \$11.90 and six-letter, \$12.50 This includes Parcel Post shipment to the United States.

To order your plaque, send your check or money order to W. J. Chapman, W6DQE, 10208 Roscoe Boulevard, Sun Valley, California 91352. He forwards the orders to DU1FH via air mail; when the plaque is completed it is mailed directly to you from the Philippines. Delivery is about 2½ months after the order is received.

technical aid

The amateur radio club at Sams Technical Institute (STI) has undertaken a "helping hand" program to assist amateurs and would-be amateurs with technical problems. This service is available to hams in all parts of the world, and is aimed particularly at those who are isolated from other amateurs or are unable to get local advice. Members of the STI Amateur Radio Club are students

working toward an Associate Degree in Electronics Engineering Technology, and have a well-trained staff of instructors to back them up. If you have a technical problem that you are unable to solve, write to the STI Amateur Radio Club, WB9ADF, Sams Technical Institute, Interstate Industrial Park, Fort Wayne, Indiana 46808. STI is affiliated with ITT Educational Services, Inc.

ic breadboard socket



A new device is now available for breadboarding with 14-pin dual-inline-package integrated circuits. The device consists of a small piece of epoxy-glass board with a 14-pin socket and two adjacent rows of Vector Springclip™ terminals; it is furnished with two pins on the bottom that may be press-fit mounted on prepunched Vectorboard (pattern AA).

This new gadget speeds up integrated circuit breadboarding because as many as four solderless connections can be made quickly with ordinary hookup wire. Logic circuitry is particularly easy to set up with the new socket because the numbered terminal pins correspond to socket contacts and interconnections between sockets can be made quickly and easily. If discrete components are required, they can be mounted on the adjacent Vectorboard.

The price of the 570G breadboard socket is \$3.95, and may be ordered from Vector Electronic Company, Inc., 12460 Gladstone Avenue, Sylmar, California 91342.

PSSST!

WANT TO ADD 4 FREQUENCIES
TO YOUR 2 METER PROGRESS
LINE RIG.....THE EASY WAY?

Check into our new
SOLID STATE, PLUG IN
4 FREQUENCY DECKS

Model 4HPR for ER25 series receivers \$22.95*
Model 4HPT for ET20 & 21 series transmitters \$22.95

*only \$19.95 each when purchased in pairs

WRITE FOR MORE INFORMATION ON THE 4HPR &
4HPT DECKS AND OUR OTHER FM PRODUCTS:

FET PREAMPS
SOLID STATE C.O.R.
2 CHANNEL SCANNERS
5 CHANNEL SCANNERS



ELECTRONICS
107 MOOREWOOD AVE.
AVON LAKE, OHIO 44012
PHONE (216) 933 8086

radio amateur callbook

Radio Amateur
Emblems engraved
with your call letters.



Charm

- Gold
 Rhodium

call letters
\$5.00 Ea.



Tie Bar

- Gold
 Rhodium

call letters
\$5.00 Ea.



Lapel Pin

All illustrations
are actual size.

- Gold
 Rhodium

call letters
\$5.00 Ea.

Rush Order To: RADIO AMATEUR CALLBOOK, Inc.

Dept. E. 925 Sherwood Drive, Lake Bluff, Ill. 60044

LINEAR AMPLIFIERS \$6.60 PER POUND

SOUND RIDICULOUS?

Not at all! That is about what you will pay whether you buy a box of parts or a fully assembled, rugged, heavy duty BTI LK-2000. Extra weight means extra dependability, plus: Adequate back-up power • Good harmonic suppression • Operating convenience • Eimac 3-1000Z • ALC • Fast acting overload protection • 80 through 10 meters • Prestige styling • Adequate cooling, even on a continuous use basis.

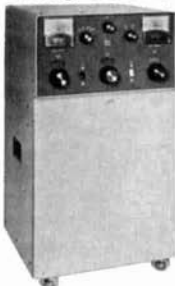

BTI LK-2000 ... For maximum legal amateur input ... 5SB, CW, RTTY.
Price \$79500

BTI LK-2000HD ... For heavy duty applications such as MARS, high power RTTY and 5SB.
Price \$89500

Write for free brochure or send \$1.00 for technical instruction manual.



BTI AMATEUR DIVISION
Hafstrom Technical Products
4616 Santa Fe, San Diego, Ca. 92109



NEW FROM TELREX

Patented Challenger Series Balun Fed Inverted-Vee® 2KWP and 4KWP Antenna Kits

Simple to set up, hi-performance antenna systems. Kits include—patented encapsulated broad-band balun, 200 ft. antenna wire, insulators and complete instructions for erecting as either Mono 40 or 80M Inverted-Vee or Fan-Dipole 40/80 Meter Inverted-Vee.

2KW Peak Model CIV2KWP ----- \$18.95

4KW Peak Model CIV4KWP ----- \$25.95

Prices postpaid continental U.S.A. Add tax if applicable. At your dealer or order direct from Telrex for fast personal service. Send for tech. & price bk. PL 70

telrex ANTENNA LABS

Asbury Park, N. J. 07712.

RADIO TELETYPE EQUIPMENT

Teletype Models 35, 33, 32, 29, 28 ASR, 28 KSR, 28 LPR, 28 LARP, 28 LXD, 28 LBXD1, 14, 15, 19, Page Printers, Perforators, Reperforators, Trans-Dist. polar relays, tape winders, cabinets, Collins Receivers, 51J-3, 51J-4, R-388, R-390A. SP600JX, Frequency Shift Converters, D.C. Power Supplies.

ALLTRONICS-HOWARD CO.

Box 19, Boston, Mass. 02101

Tel: 617-742-0048

SURPLUS CRYSTAL FILTERS AND DISCRIMINATORS

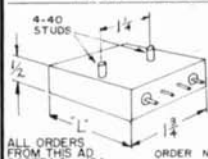

ALL ORDERS FROM THIS AD POSTPAID, USA

ORDER NO. MEL-3 \$14

SIX CRYSTAL FILTER
 CENTER FREQUENCY 11.5 MHZ
 6 DB BANDWIDTH 35 KHZ MIN
 60 DB BANDWIDTH 100 KHZ MAX
 PASSBAND RIPPLE 1.0 DB MAX
 IN & OUT TERMINATION 50 OHMS
 INSERTION LOSS 3.0 DB MAX
 ULTIMATE ATTENUATION 75 DB MIN
 "L" DIMENSION 1.34 INCHES

MATCHING FM CRYSTAL DISCRIMINATOR — ORDER NO. MAL-1 \$10
 SIMILAR PACKAGE EXCEPT "L" DIM IS 1.04 IN. — CENTER FREQ. 11.5 MHZ
 RECOMMENDED DEVIATION ± 10 KHZ — PEAK TO PEAK MIN BW 50 KHZ
 TERMINATIONS: INPUT 1000 Ω , OUTPUT 100K Ω — DOPE SHEET INC

10.7 MHZ FILTERS — 2 $\frac{3}{8}$ LONG, 1.0 WIDE, 1 $\frac{1}{32}$ HEIGHT

10.7 MHZ 8 CRYSTAL FILTER MOD FB-5 \$19
 6 DB BW 13 KC MIN — 60 DB BW 25 KC MAX
 IN & OUT ≥ 1 K Ω — ULT. ATTENUATION 100 DB

HERMES MOD 10MA 6 CRYSTAL FILTER \$14
 6 DB BW 30 KC MIN. — 60 DB BW 75 KC MAX
 IN & OUT ≥ 2 K Ω — ULT. ATT 80 DB MIN



COMING SOON — WATCH FOR ANNOUNCEMENT OF OUR OWN 9 MHZ SIDEBAND 8 CRYSTAL FILTER. LOW PRICE.

WE HAVE SURPLUS FILTERS WITH BANDWIDTHS FROM 400HZ TO 210 KHZ, CENTER FREQUENCIES FROM 80 KHZ TO 36 MHZ.

SEND DIME FOR LIST OF OVER 50 TYPES OF SURPLUS CRYSTAL FILTERS & DISCRIMINATORS. INCLUDES HYCON-EASTERN, HERMES, ITEK, MIDLAND-WRIGHT & ELECTRA/MIDLAND TYPES.

J.T. McCULLOUGH, W0BHG — TEL. 816-781-5666 (K.C., MO.)

ESEL **Excelsior Springs Electronic Labs**
 301 AUGUSTUS
 EXCELSIOR SPRINGS, MO. 64024

New! SPEECH compressor

- Increase talk power drastically!
- Installs internally - always with you -
Fixed - Mobile - DXpeditioning!
- Works with Phone Patch
- Fully wired - not a kit
- No Holes 15 min. installation in
HW100, SB101, SB401 and others
- Full year warranty - free literature

MODEL RPC-3 **R_p Electronics**
 \$24.⁹⁵ BOX 1201
 POSTPAID CHAMPAIGN, ILL. 61820

5-band receiver



Allied Radio has introduced a new moderately priced 5-band amateur receiver that features a mechanical filter to provide highly selective a-m, cw and ssb reception on all ham bands between 3.5 and 29.7 MHz. It also tunes the WWV frequency and time standard signal on 10 MHz. The dual-conversion design features a crystal-controlled first oscillator and exceptionally stable solid-state vfo. The vfo has convenient output terminals for use as a transmitter vfo.

Remote-control terminals on the receiver permit easy switching to standby; agc and anl circuits give constant level audio and quiet reception. A calibrated S-meter aids tuning and provides an accurate signal strength indication; 500-ohm output terminals are provided for recording use, and as an output source for RTTY connections.

The mechanical filter provides a 1.5 kHz bandwidth at 6 dB down, 6 kHz at 60 dB down. Sensitivity is 1.5 μ V for 10 dB signal-to-noise ratio at 14 MHz. Image ratio and i-f rejection are better than 40 dB at 14 MHz. The circuit uses 7 tubes, 2 transistors and 5 diodes.

An anti-backlash double-gear tuning dial provides accurate, direct-reading down to 1 kHz; a smooth 28:1 dial-speed ratio facilitates precise tuning.

The Allied A-2516 ham receiver is priced at \$169.95 with olive-gray metal case. A matching 5-inch speaker is available for \$19.95. Allied Radio Corporation, 100 N. Western Avenue, Chicago, Ill. 60680. 1970 Catalog sent free on request.

WE PAY **HIGHEST**
 PRICES FOR ELECTRON
 TUBES AND SEMICONDUCTORS

H & L ASSOCIATES

ELIZABETHPORT INDUSTRIAL PARK
 ELIZABETH, NEW JERSEY 07206
 (201) 351-4200

FM

PACKAGE

from



Ham Radio published over 50 pages of top notch FM articles in 1969.

They cover everything from the latest ideas in repeater design to the most complete introduction to amateur two-way FM ever published.

Send today for our FM Package
A collection of
these six exciting back issues.

While they last
Only \$2.50

ALL 11 — 1969 ISSUES
STILL AVAILABLE
\$4.00

HAM RADIO MAGAZINE
GREENVILLE, NH 03048

WARNING

DUE TO HIGHER COSTS WE WILL
SOON HAVE TO RAISE OUR PRICES
BUY NOW & SAVE

GEM-QUAD FIBRE — GLASS

ANTENNA FOR 10, 15, and 20 METERS.



Two Elements \$77.73
Extra Elements \$45.00 ea.
Shipped Freight Collect
INCLUDES U.S. Customs Duty

KIT COMPLETE WITH

- SPIDER
- ARMS
- WIRE
- BALUN KIT
- BOOM WHERE NEEDED

SEE OUR FULL PAGE IN JUNE '69 ISSUE

Buy two elements now — a third and fourth may be added later with little effort.

Enjoy optimum forward gain on DX, with a maximum back to front ratio and excellent side discrimination.

Get a maximum structural strength with low weight, using our "Tridetic" arms.



MANITOBA DESIGN INSTITUTE
AWARD WINNER

Structural Glass
1967-68

20 Burnett Avenue, Winnipeg 16, Manitoba, Canada

BARRY PAYS CASH FAST

You can be sure with Barry . . .
Fair dealing since 1938

Send lists of your unused TUBES,
Receivers, Semi-Conductors,
Vac. Variables, Test Equipment, etc.

No Quantity too Small.
No Quantity too Large.

Write or Call now . . . BARRY, W2LNI

BARRY ELECTRONICS
512 BROADWAY • NEW YORK, N. Y. 10012
212 - WA 5-7000

Regul. Pwr Sply For Command, LM, Etc.:

PP-106/U: Metered. Knob-adjustable 90-270 v up to 80 ma dc; also select an AC of 6.3 v 5A, or 12.6v 2½ A or 28 v 2½ A. With mating output plug & all tech. data. Shpg. wt. 50 lb. 19.50

Bargains Which The Above Will Power:

LM-(*) Freq. Meter: .125-20 mhz, .01%, CW or AM, with serial-matched calib. book, tech. data, mating plug. Checked & grtd. Shpg. wt. 16 lbs. 57.50
 TS-323 Freq. Meter: Similar to above but 20-480 mhz. .001%. With data. 169.50
 A.R.C. R11A: Modern Q-5'er 190-550 khz 12.95
 A.R.C. R22: 540-1600 khz w/tuning graph 17.95

High-Sensitivity Wide-Band Receiver

COMMUNICATIONS . . . BUG DETECTION . . .
 SPECTRUM STUDIES

38-1000 MHZ: AN/ARL-5 consists of a brand new Tuner, CV-253/ALR and an exc. used rcvr R-444 modified for 120 v, 50/60 Hz. The tuner covers the range in 4 bands. Packed with each tuner is the factory checkout sheet. The one we opened showed SENSITIVITY: 1.1 uv at 38.3 mhz, 0.9 at 133 mhz, 5 at 538 mhz, 4½ at 778 mhz, 7 at 1 ghz. The rcvr is actually a 30 mhz IF ampl. with all that follows an IF including an S meter. Has Pan, Video & AF outputs. Has a calibrated attenuator in 6 db steps to -74 db, also AVC position. Select pass of ±200 khz or ±2 mhz. AND SELECT AM OR FM! We furnish Handbook & pwr- input plug, all for **\$275.00**

SP-600-JX(*) Rcvr: 0.54-54 mhz. the popular late-type Hammarlund Super-Pro. aligned, grtd, exc. **325.00**
 physical cond. too, w/book.

R-390/URR Rcvr: Collins xtl-calib. each 100 khz. Aligned & grtd. perfect. **795.00**

\$2000 Master Oscil., Xmtr or Rcvr

TMC VOX-2 (0-330/FR): 2-64 mhz VFO, read out to 7 places. Resettability & Stability better than 20 PPM. Xtl in double-controlled oven, calib each 50 khz, plus 6 xtl-controlled freq. Po to 75 ohms 2 W 2-4 mhz (fund.), ½ W 4-64 mhz. Replaces xtl osc. in xmtr or use as local osc in rcvr. Exc. cond. w/all tech data. 179.50

R. E. GOODHEART CO. INC.

Box 1220-HR, Beverly Hills, Calif. 90213
 Tel: Area 213, office 272-5707, messages 275-5342

DON'T FORGET

HAM RADIO BINDERS \$3.95
 HAM RADIO BOUND VOLUMES . . . \$14.95
 Volume 1, 1968

Order from
HAM RADIO MAGAZINE
 GREENVILLE, N. H. 03048



**MIDLAND
 SWR AND
 POWER
 METER**

Reads output and reflected power simultaneously. May be left in line up to 2000 watts. Low insertion loss. Size 5x2x2. Good to 175 Mhz. **PRICE \$15.95, FOB HOUSTON.**

MADISON ELECTRONICS SUPPLY

1508 MCKINNEY — HOUSTON, TEXAS 77002
 (713) 224-2668

radio amateur callbook

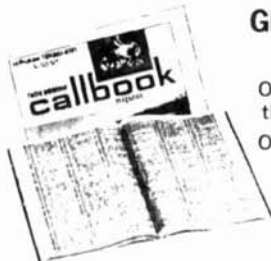

GET YOUR NEW ISSUES NOW!

Over 290,000 QTHs in the U.S. edition **\$7.95**

Over 140,000 QTHs in the DX edition **\$5.95**

NEW EDITION EVERY:
 MARCH 1 — SEPT. 1
 JUNE 1 — DEC. 1

These valuable EXTRA features included in both editions!

- QSL Managers Around the World!
- Radio Amateurs' Prefixes by Countries!
- A.R.R.L. Phonetic Alphabet!
- Where To Buy!
- Great Circle Bearings!
- World Prefix Map!
- International Radio Amateur Prefixes
- International Postal Information!
- Plus much more!

See your favorite dealer or order direct (add 25¢ for mailing in U.S., Possessions & Canada. Elsewhere add 50¢).

WRITE FOR FREE BROCHURE!



RADIO AMATEUR
callbook INC.

Dept. E. 925 Sherwood Drive
 Lake Bluff, Ill. 60044



CAMP ALBERT BUTLER INVITES HAM RADIO ENTHUSIASTS OF ALL AGES

TO TRY FOR YOUR
GENERAL CLASS TICKET

This Summer! Our 11th Season

**STUDY INSTRUCTION
 LEADING to GENERAL ADVANCE
 and AMATEUR EXTRA LICENSE**

This co-ed Amateur Radio Camp, Y.M.C.A. owned and operated, can accommodate 60 campers. There is no age limit. We have had campers from 7 through 74 years of age. It is very helpful if you can copy 5wpm or have a Novice or Technician ticket, but it is not necessary. Time is divided between radio classes in code and theory and usual camp activities, such as swimming, archery, riflery, hiking, etc. Golf privileges are included at the beautiful New River Country Club course.

Entire staff consists of licensed hams who are instructors in electrical engineering in some of our finest colleges and universities. Camp opens August 1 and closes August 15th. Tuition of \$200.00 includes all camp expenses: room, meals, notebooks, textbooks, and insurance. Send for our brochure.

C. L. Peters, K4DNJ
 General Secretary
 Gilvin Roth Y.M.C.A., Elkin, N. C. 28621

Please send me the Booklet and Application Blank for the Camp Albert Butler Radio Session.

NAME _____
 CALL _____
 ADDRESS _____
 CITY _____ STATE _____ ZIP _____

FERRIC-CHLORIDE etchant for printed circuit boards. Sent dry, just add water. Makes 1/2 gallon or mix only the quantity you need.

\$2.00 postpaid

NUGENT

3E 41 PLACE, SAN MATEO, CALIF. 94403

WE PAY CASH FOR TUBES

LEWISPAUL ELECTRONICS INC.
303 W. Crescent Avenue
Allendale, New Jersey 07401

ALL BAND TRAP ANTENNA!



Reduces interference and noise on ALL Makes Short Wave Receivers. Makes World Wide Reception Stronger. Complete with 30 ft. 72 ohm feedline. Sealed resonant traps. For novice and class radio amateurs! Eliminates 5 separate antennas with battery performance guaranteed 40-40 to 10 meter bands. Complete 100 ft. \$19.95. 40 to 10 to 10 meter bands. 54 ft. (best for world wide short wave reception) \$18.95. Send only \$3.00 cash, ck. mol. and pay postman balance COD plus postage on arrival or send full price for postpaid delivery. Complete instructions included!
WESTERN ELECTRONICS Dept. B-12 Kearney, Neb. 68847

GET MONEY

Guaranteed top money for any piece of surplus equipment. Payment in 24 hours. We also pay shipping, insurance. Call collect or send list for quick quote. SPACE ELECTRONICS CORP. 11 Summit Ave. East Paterson, New Jersey, (201) 791-5050



BUGS ARE OK... keys are better

Our **ELECTRONIC FIST** is the best!
Send 50¢ for the CONSTRUCTION MANUAL,
And see for yourself.....
(Now with SPACE COMPRESSION).

Dealer Inquiries Invited

GAURINS ELECTRONIC DEVICES Dept. H, Box 4090 Mountain View, California 94040

LIBERTY PAYS MORE!!

WILL BUY FOR CASH — ALL TYPES
Electron Tubes • Semiconductors • Test Equipment
• Military Electronic Equipment

Wire, write, phone collect! We pay freight on all purchases!
LIBERTY ELECTRONICS, INC.
548 Broadway, New York, N. Y. 10012
Phone: 212/925-6000

WORLD QSL BUREAU

PLAN 1. WE FORWARD YOUR QSLs (PLEASE ARRANGE ALPHABETICALLY) TO ANY PLACE IN WORLD, INCLUDING ALL FOREIGN COUNTRIES, AND TO OR WITHIN USA, CANADA, AND MEXICO, FOR 4¢ EACH.
PLAN 2. YOU USE OUR SPECIAL LOG FORM AND SEND US A COPY. WE SUPPLY QSL — MAKE OUT QSL — DELIVER QSL, ALL FOR 8¢ EACH.

5200 Panama Ave., Richmond, CA USA 94804

DAYTON HAMVENTION

Saturday, April 25, 1970

Dayton Hara Arena and
Exhibition Center

- Technical Sessions • Women's Activities
 - Exhibits • Flea Market • Awards • Banquet
- Dayton Amateur Radio Association
Dept. H: Box 44 Dayton, Ohio 45401

DIODES

PIV	TOP-HAT 1.5 AMP	EPOXY 1.5 AMP	EPOXY 3 AMP	STUD- MOUNT 6 AMP
50	.04	.06	.12	.15
100	.06	.08	.16	.20
200	.08	.10	.20	.25
400	.12	.14	.28	.50
600	.14	.16	.32	.58
800	.17	.20	.40	.65
1000	.20	.24	.48	.75

PRICES PPD. U. S. A.

PA. RESIDENTS ADD 6% PA. SALES TAX

M. WEINSCHENKER K3DPJ

PO BOX 353, IRWIN, PA. 15642

NEW ARRIVALS — CRAZY PRICES

- SA-215/U \$8.50 each
DPST, double break, antenna switch. Will handle 1 KW, at 50 ohms; has 4 receptacles to take UG-21/U (N type) co-ax connectors. 3 1/2" dia. 5" long; with mounting bracket. 4 1/4" mounting centers. (5#). With 4 UG-21/U, NEW. \$9.75
- BB-403/U \$3.00 each
Nickel-cadmium batteries, 1.2v DC, 2 1/2 amp-hr (mil spec) 4 amp-hr (commercial). 2" wide, 1/2" thick, 6 1/2" high. (1#) Nylon Case, 4/\$11.50, 10/\$27.00
As above, 24 nylon cased, in steel cabinet, for 28v DC. \$50.00 case.
- BB-401/U \$2.75 each
Individual cells, removed from case, 4 for \$10.50.
- RFC \$1.29 each
2 1/2 mhy, 5 ohm, 1 amp. 6 pi, on 1/2" dia. 3 1/2" long, ceramic form, with mounting feet, solder terminals. (1#). 4 for \$4.75
- S Meter \$2.25 each
2 1/2" sq. wide view, plastic case. Basic 1 MA DC 4/\$8.50
- VU Meter \$2.25 each
2 1/2" sq. wide view, plastic case. Illuminated. White figures, black background. 4 for \$8.50

PLEASE — include sufficient for postage. Any excess refunded, with the order.

B C Electronics

Mailing Address

5058 N. CLAREMONT AVENUE
CHICAGO, ILLINOIS 60625

PH. 312-334-4463, if no answer, 784-4426

... STORE HOURS ...

Wed. & Sat. 10:00 a.m. to 3:00 p.m.
5696 N. Ridge Avenue, Chicago

EAST COAST FM CONVENTION

in conjunction with the

ORLANDO HAM-FEST

MAY 23-24, 1970

HILTON INN and JAMAICA INN
W Colonial Drive, Orlando, Florida

FM TALKS, AND
TECHNICAL SEMINARS
SOUTHEAST REPEATER
ASSOCIATION MEETING
ADVANCE FM REGISTRATION
DOOR PRIZE
REPEATER TALK IN:
146.34 TO 146.76 MHZ

Special advance reservations are
being taken for the FM convention
and lodgings at the Jamaica Inn.
Send stamped, self-addressed en-
velope for advance FM reserva-
tions and accommodations.

Registration \$2.00
Accommodations Single \$10.00
Double \$13.50

S. E. R. A.
BOX 82
PALM BAY, FLORIDA 32901

Advertisers Index

Aerotron, Inc.	83
Alltronics - Howard Co.	89
Amateur Electronic Supply	67
BC Electronics	93
Barry Electronics	91
Baton Rouge Hamfest	87
Camp Albert Butler	92
Communication Technology Inc.	50, 59
Curtis Electro Devices	93
Dames Co., Ted	77
Dayton Hamvention	93
East Coast FM Convention	94
Eimac Division of Varian	5
Excelsior Springs Electronic Labs	90
Goodheart Co., Inc., R. E.	92
Gordon Co., Herbert W.	96
H & L Associates	90
HAL Devices	81
Hafstrom Technical Products	89
Ham Radio Magazine	55, 81, 91
Hammarlund Manufacturing Co.	39
Harrison Radio	2
Henry Radio	2
International Crystal Manufacturing Co.	21
Jan Crystals	83
KN Electronics	89
Lewispaul Electronics, Inc.	93
Liberty Electronics	93
Madison Electronics Supply	92
Micro-Z Electronics Corp.	87
Military Electronics Corp.	93
National Radio Co., Inc.	Cover II
Nugent	93
Phase Corp.	71
RP Electronics	90
Radio Amateur Callbook, Inc.	83, 89, 92
Radio Shop, Lab 1	81
Sentry Manufacturing Co.	1
Signal/One	Cover IV
Spectronics	Cover III
Spectrum International	72
Stellar Industries	95
Structural Glass, Ltd.	91
Swan	6, 7
Telrex Communication Engineering Laboratories	89
Vanguard Labs	81
Varitronics	49
Weinschenker, M.	87, 93
Westcom Engineering Co.	70
Western Electronics	93
World QSL Bureau	93

IN STOCK



Collins S-Line and Accessories

AT

stellar

10 GRAHAM ROAD WEST • ITHACA, N. Y. 14850

TELEPHONE AREA CODE 607-257-2424

51J AND R390 SERIES COMMUNICATIONS RECEIVER



At a time when Communications equipment has become more sophisticated, more reliable and more condensed in size; the trade has been offered less and less in variety and quality than ever before. So as to reverse this trend we offer the 51J and 390 series receivers. Although created in the 50's for military surveillance work these superb sets have been overhauled and modernized and generally speaking are the very best short wave communications radios available. To those of you discerning readers who, tired of mediocrity, want the last word — consider the purchase of a 390 or 51J.

The 390 or 390A or 391 offers digital readout to any discrete frequency within the range of 540 KHz thru 32 MHz to an accuracy of 300 Hz. You can tune to WWV or CHU while the set is off and cold — then turn on the set — turn up the volume and have your station perfectly tuned in. Of maximum sensitivity, the 390 series

offers six steps of selectivity from a gate of 100Hz thru 16KHz. Moreover, if used for Moonbounce or sophisticated converter work there is also an audio filter to further narrow the bandpass to as little as 10Hz. Two audio channels, a Geneva drive and a remarkable avc bus are also features of these fine sets.

We have installed compatible sideband detector in these sets and have thoroughly rebuilt each module such that we can warrant each set for a full 180 days from your receipt. Having tried the rest why not have the best — contact us today for a delivery schedule to meet your needs. Prices are FOB Harvard but include Operating and Instruction Book and special shipping container.

Prices for 51J series from \$600 to \$1033.

Prices for 390 series from \$1133 to \$2033.

Call us today for more information.

HERBERT W. GORDON COMPANY

HELPING HAMS TO HELP THEMSELVES

Woodchuck Hill Road  *Harvard, Mass. 01451*

PHONE 617 456 3548

\$229.95

C



\$ 19.95

D

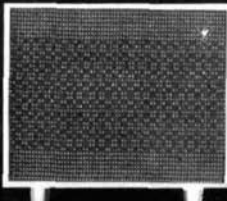

YAESU "F" LINE

B

\$99.95



A

\$449.95

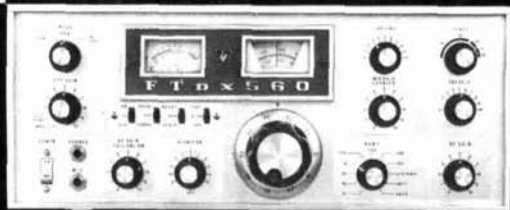

3 steps ahead

NOW, DIRECT TO THE AMATEUR. SPECTRONICS OFFERS PRECISION EQUIPMENT/DELUXE FEATURES/LOW COST

A FT dx 560 TRANSCIVER

Best buy in a transceiver today, the FT dx 560 is a complete station in one package. Design features include zero backlash planetary tuning dial easily read to less than 500 cycles. Double conversion tunable I.F. system which results in drift free operation combined with high receiver sensitivity. Compare the features and specifications of this fully integrated transceiver before you make your next purchase.

Features: Built-in AC power supply, built-in VOX, built-in dual calibrators (25 and 100 KHz), built-in Clarifier (off set tuning), all crystals furnished 80 through the complete 10 meter band, provision for 2 additional auxiliary transceiver bands outside of the amateur frequencies, 10 MHz WWV receive band built in, break-in CW with sidetone, selectable USB & LSB.

Specifications: Maximum input: 560 W PEP SSB, 500 W CW. Sensitivity: 0.5µV, S/N 20 db. Selectivity: 2.3 KHz (6 db down). 3.7 KHz (60 db down). Carrier Suppression: More than 40 db down. Sideband suppression: More than 50 db down at 1 KHz. Frequency range: 3.5 to 4, 7 to 7.5, 14 to 14.5, 21 to 21.5, 28 to 30 (megahertz). Frequency stability: Less than 100 Hz drift in any 30 minute period after warm up.

Complete only \$449.95

B FV-400S EXTERNAL VFO

Companion External VFO for the FT dx 560 Transceiver, the FV-400S enables cross band operation and provides the operator with separate receive-transmit capability.

FV-400S features solid-state oscillator, buffer, and regulator. Covers frequency range from 8.4 to 8.9 MHz, and is powered by 6.3 volt AC supply. The same heavy duty gear Train is used in the VFO as in the FT dx 560 Transceiver. Frequency stability is less than 100 Hz drift in any 30 minute period.

Complete only \$99.95

C FL dx 2000 LINEAR AMPLIFIER

Full 1200 W PEP SSB or 1000 W CW Linear compatible with any 30-100 W exciter. Features built-in solid state power supply, SWR bridge, manual or automatic exciter controlled relay, ALC connection provided, forced air cooling, 117 or 220 V AC Operation optional, built-in low pass filter, grounded grid circuit.

Desk top size, 6¼" high, 14½" wide, 11½" deep, weight approximately 40 lbs. Front panel is styled in nonspecular chrome with back lighted meter face and operating indicator lights. Heavy steel cabinet finished in functional blue-gray.

Complete only \$229.95

D SP-560 SPEAKER

Matching heavy duty speaker completes the "F" Line Station. Unit is specially designed for voice frequency range.

Complete only \$19.95

SPECTRONICS WEST

BOX 338 ■ LAKEWOOD, CALIF. 90714

SPECTRONICS EAST

BOX 1457 ■ STOW, OHIO 44224

Write for literature or order direct from Spectronics

Spectronics warrants the F Line for a period of one year after date of sale. Continuing service is available for complete satisfaction.

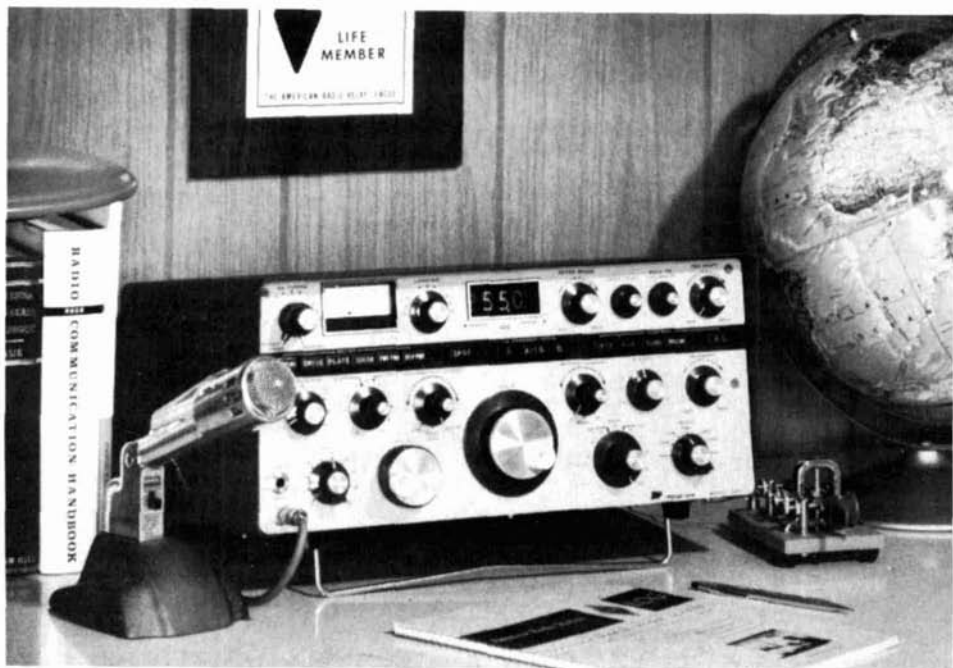

*Please don't call it a **TRANSCIVER**...*

Some people don't like transceivers. Too much **compromise**, they claim... only **separate** transmitters and receivers can deliver really top-notch performance under all conditions...

Pretty hard to argue that point... UP UNTIL NOW!

BUT NOW... SIGNAL/ONE brings you the DELUXE INTEGRATED STATION...

... **more** performance than any transmitter/receiver combination

... **more** convenience than any transceiver

... **unprecedented versatility**

WHATEVER YOUR CHOICE IN THE PAST...

COMPARE IT POINT-BY-POINT with the NO-COMPROMISE CX7...

COMPARE the CX7 with any receiver for sensitivity, selectivity options, dynamic

range, AGC merit, VFO smoothness, interference rejection...

COMPARE the CX7 with any transmitter for continuous power output in all modes, P.A. ruggedness, crisp audio punch, low distortion, instant CW break-in and spotting, quick band-change...

COMPARE the CX7 with any transceiver for total size and weight... the extreme flexibility of its dual-channel system... the convenience of its completely self-contained design...

CONSIDER the CX7's **incomparable** frequency coverage and readout precision... aerospace-bred excellence in engineering and craftsmanship... built-in "extras"... overall versatility...



"It Speaks for Itself"

signal/one

A Division of ECI (An NCR Subsidiary)

2200 Anvil Street N. • St. Petersburg, Florida 33710